



LINTA

LINEAR ARCHITECTURAL FIXTURES

Distinctive. Elegant. Simple.

SINCE 1945
KEYSTONE
LIGHT MADE EASY®





Beautifully simple

Introducing Linta. Architectural lighting from Keystone.

It's a linear direct/indirect fixture that's elegant, modern, and versatile. A fixture that's attuned to your style – and your project budget.

Linta fixtures link seamlessly with simple, intuitive connections. Join them together to form straight lines or angled figures. Easily transition the ambience of your space with field-adjustable uplighting and downlighting, and select the right color temperature and lumen output for any room with the touch of a switch.

The length and look is up to your imagination.

It's easy to specify, easy to order, and easy to install. And, in particular, easy to design the light you want in your space.

That's Linta by Keystone. Light Made Easy®.

Simple connections

Linta is available in four lengths—2 feet, 3 feet, 4 feet, and 8 feet—as well as X shapes, T shapes, and L shapes.

Installation couldn't be simpler. The provided toolless brackets feature a snap-and-lock design that allows you to link fixtures seamlessly and firmly, and with pre-installed connectors, you can hook up power and dimming in seconds.

For an even smoother look, an optional 32-foot rolled polycarbonate lens can be cut to length to minimize seams on multiple fixture runs.

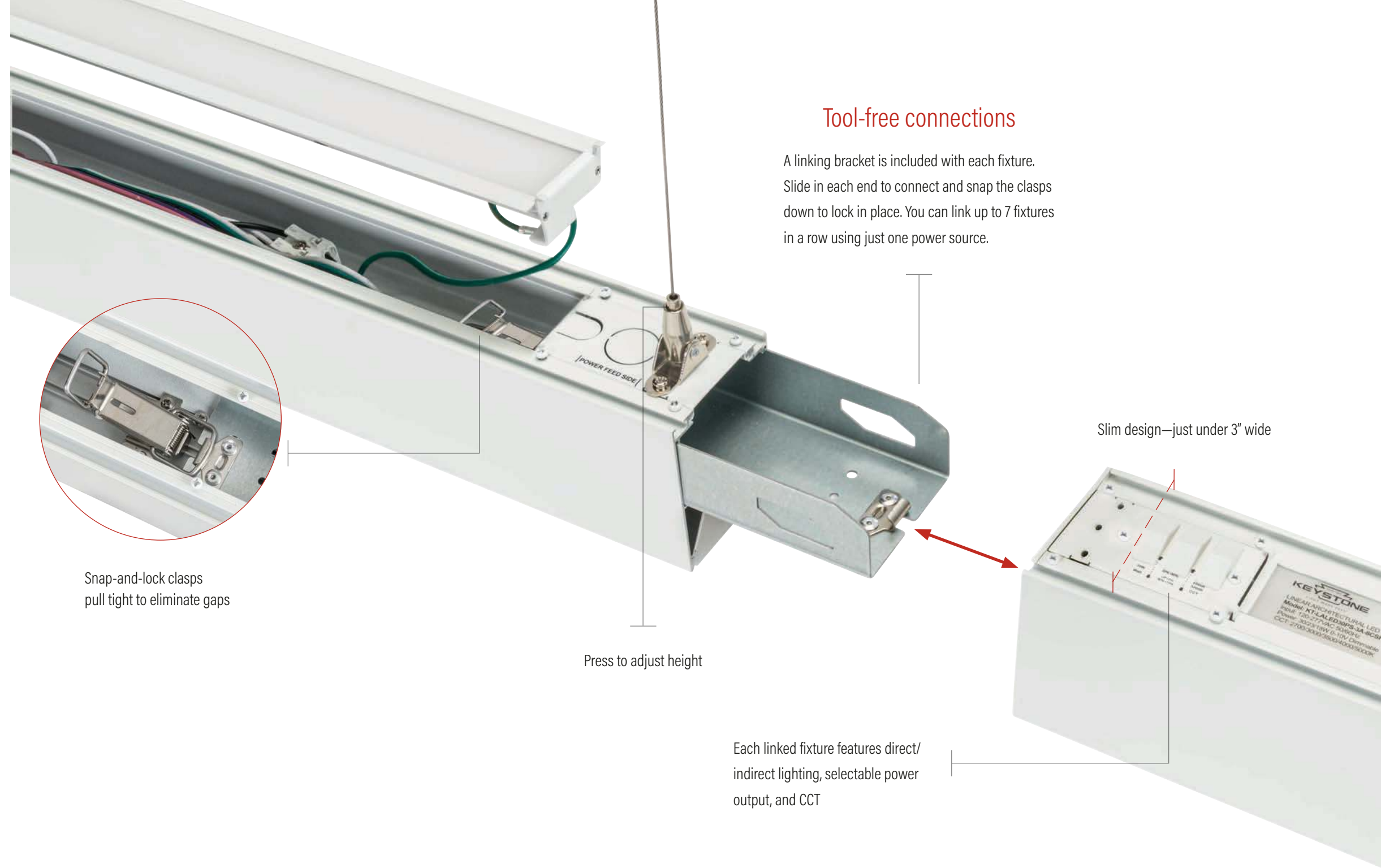

Tool-free connections

A linking bracket is included with each fixture. Slide in each end to connect and snap the clasps down to lock in place. You can link up to 7 fixtures in a row using just one power source.

Snap-and-lock clasps pull tight to eliminate gaps

Press to adjust height

Slim design—just under 3" wide

Each linked fixture features direct/indirect lighting, selectable power output, and CCT

Endless configurations and possibilities

Create singular designs with distinctively shaped fixtures. Each features uniform lighting that eliminates corner hot spots. They also offer the same simple connections as our linear fixture.

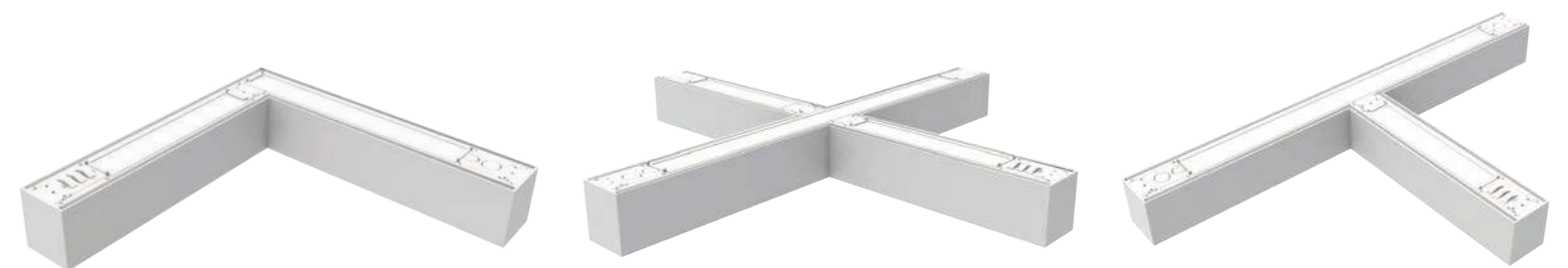

L Fixture

X Fixture

T Fixture

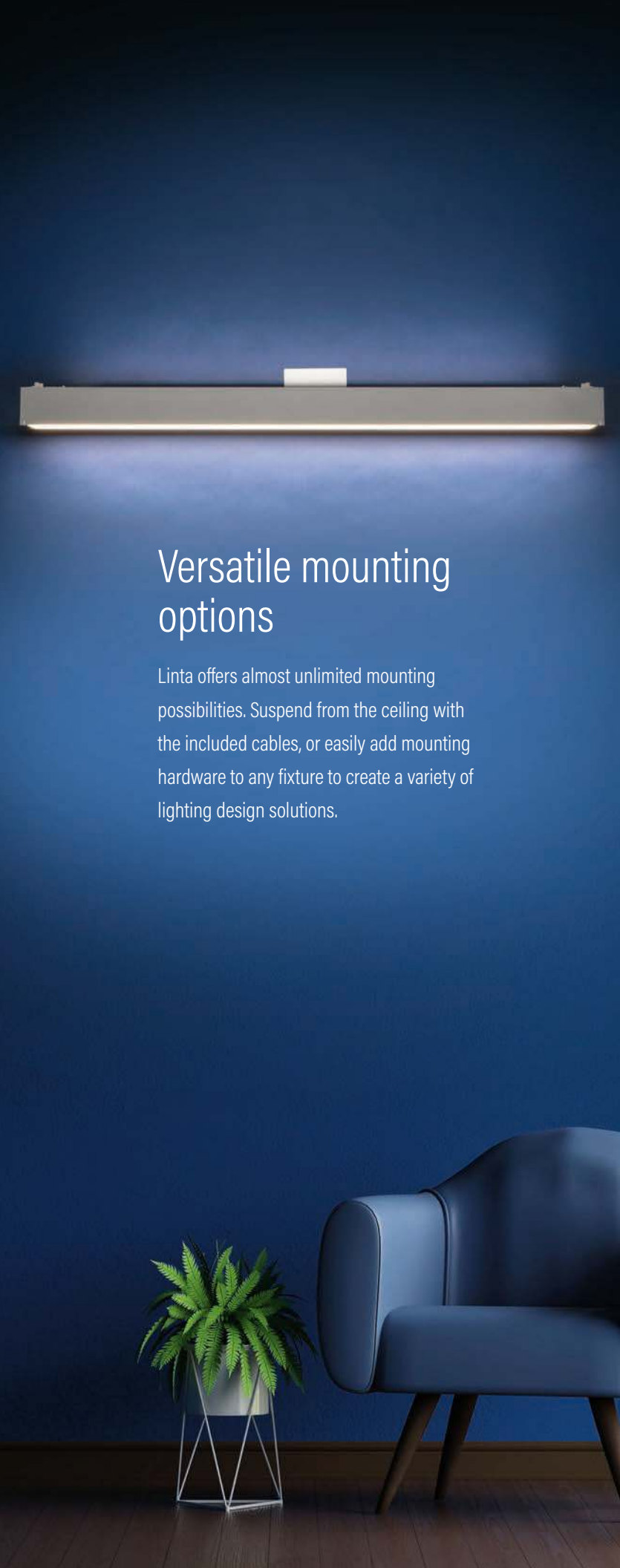

Versatile mounting options

Linta offers almost unlimited mounting possibilities. Suspend from the ceiling with the included cables, or easily add mounting hardware to any fixture to create a variety of lighting design solutions.

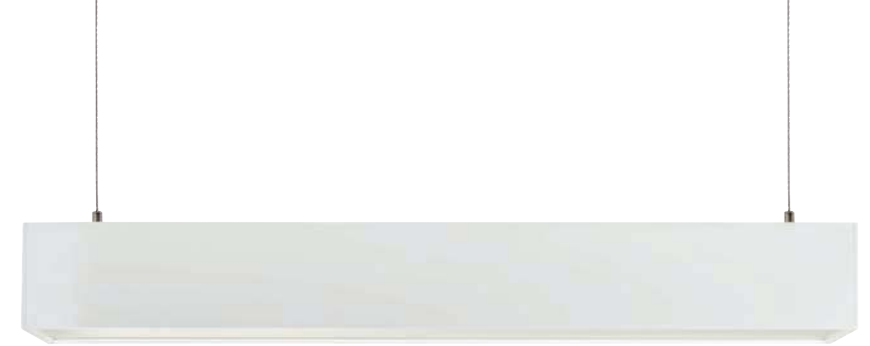

Hang as a pendant . . .

Included in the box with every fixture, your choice of two cable styles for pendant mounting from any ceiling:

- Standard 15' aircraft cable with tapped base coupler hardware
- Looped-end cables with adjustable "Y" grippers

A wide variety of canopy cover feed and non-feed kits are also available to suit all potential suspension installation needs.

. . . or, add a kit and mount on a wall or ceiling

Quickly add a mounting kit to any fixture length and expand your mounting options. Linta can be mounted flush against the ceiling, in the plenum, or on a wall.

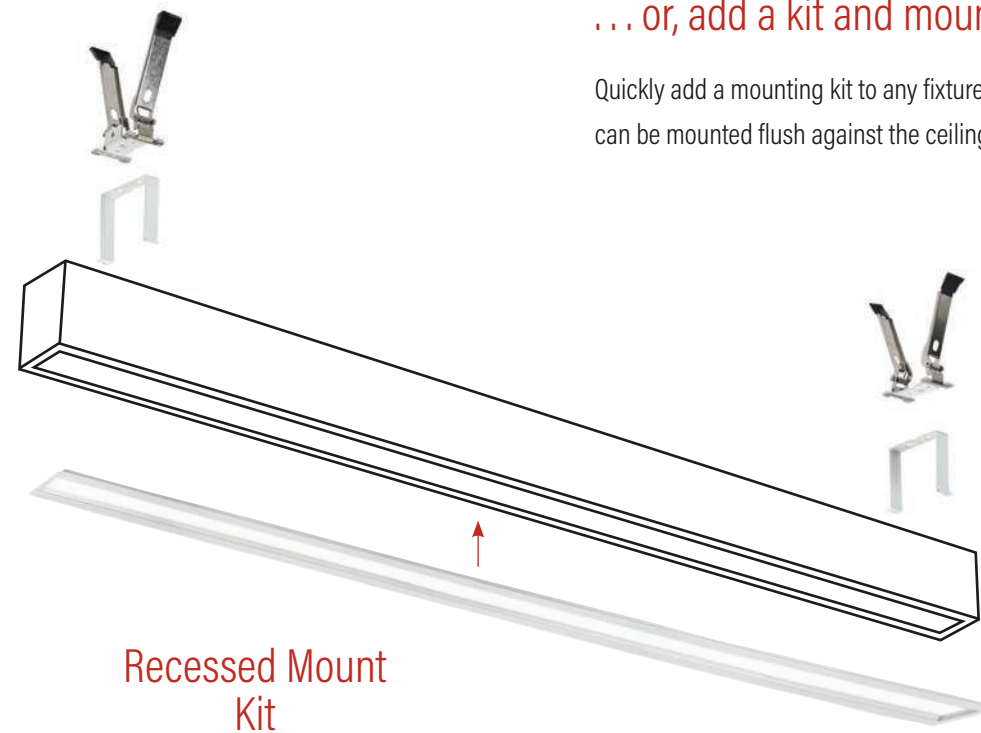

Recessed Mount Kit

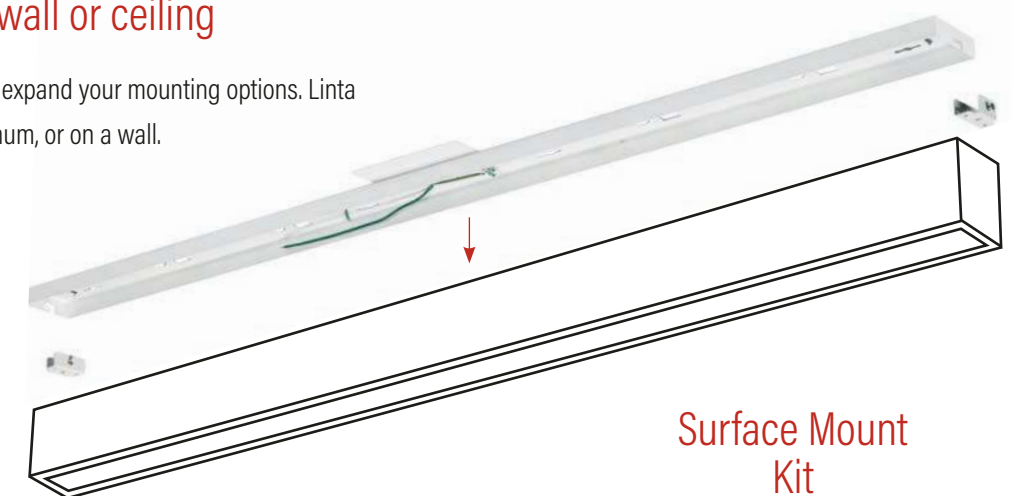

Surface Mount Kit

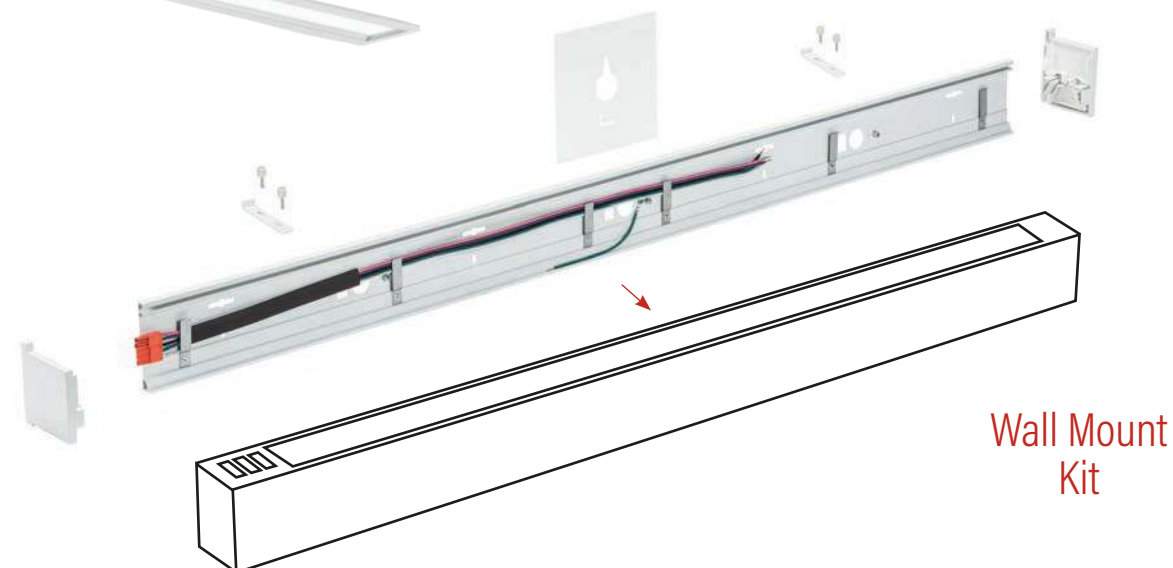

Wall Mount Kit



Watch the video

It's 45 fixtures in just one elegant design.

Illumination made simple

Linta: The power of many fixtures in one elegant design.

- Direct (downlighting) and indirect (uplighting) lighting settings are as easy as flicking a switch.
Choose between:
 - 100% direct
 - 50% direct / 50% indirect
 - 70% direct / 30% indirect
- Keystone Power Select technology with 3 selectable power outputs
- Keystone Color Select with 5 selectable CCT:
 - 2700K, 3000K, 3500K, 4000K, and 5000K.



Integrated
Emergency
Backup



Advanced customization

For emergency lighting needs, Linta is designed to work with Keystone SmartSafe emergency battery backups.

Further customize your Linta installation with Keystone SmartLoop wireless controls. Simply add the available custom-designed end cap and fine-tune the light beyond the selectable switches.



SmartLoop
Wireless

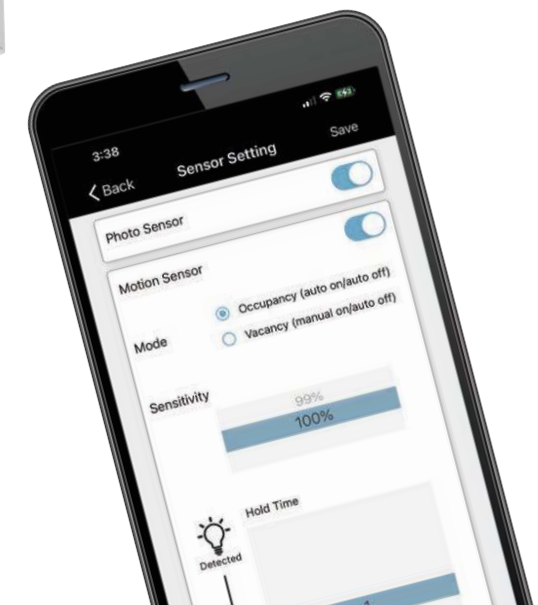

White Fixtures & Shapes



Power and Color Select

CATALOG NUMBER	NOMINAL SIZE	SELECTABLE WATTAGE	LUMENS	SELECTABLE CCT	EFFICACY	INPUT VOLTAGE	DIMMABLE	DLC	CRI
KT-LALED20PS-2A-8CSF-VDIM	2' Linear	20W	2620	2700K 3000K 3500K 4000K 5000K	131 lm/W	120-277V	0-10V	Yes	>80
		15W	1965						
		12W	1575						
KT-LALED30PS-3A-8CSF-VDIM	3' Linear	30W	3930	2700K 3000K 3500K 4000K 5000K	131 lm/W	120-277V	0-10V	Yes	>80
		23W	3015						
		18W	2360						
KT-LALED40PS-4A-8CSF-VDIM	4' Linear	40W	5240	2700K 3000K 3500K 4000K 5000K	131 lm/W	120-277V	0-10V	Yes	>80
		30W	3930						
		25W	3275						
KT-LALED80PS-8A-8CSF-VDIM	8' Linear	80W	10480	2700K 3000K 3500K 4000K 5000K	131 lm/W	120-277V	0-10V	Yes	>80
		60W	7860						
		50W	6550						

Power and Color Select

CATALOG NUMBER	FIXTURE SHAPE	SELECTABLE WATTAGE	MAXIMUM LUMENS	SELECTABLE CCT	EFFICACY	INPUT VOLTAGE	DIMMABLE	DLC	CRI
KT-LALED25PS-LA-8CSF-VDIM	L Shape	26W	3250	2700K 3000K 3500K 4000K 5000K	125 lm/W	120-277V	0-10V	Yes	>80
		16W	4625						
		20W	6250						
KT-LALED37PS-TA-8CSF-VDIM	T Shape	37W	3250	2700K 3000K 3500K 4000K 5000K	125 lm/W	120-277V	0-10V	Yes	>80
		30W	4625						
		23W	6250						
KT-LALED37PS-XA-8CSF-VDIM	X Shape	50W	3250	2700K 3000K 3500K 4000K 5000K	125 lm/W	120-277V	0-10V	Yes	>80
		38W	4625						
		30W	6250						

White Canopy Kits

Create a streamlined, modern look with Keystone canopy kits. Our hardware and accessories add the finishing touch to your Linta installation.



Shows a typical installation

Round

<p>KT-LALED-CC-UNV-NF-KIT / A</p> <p>Universal Canopy Cover Non-Feed Kit, J-Box/Stud/T-Bar/Drywall/Masonry Mount 2" & 5" Circular Covers 2 piece & 1 piece coupler White. No aircraft cable included (re-use aircraft cable supplied with each fixture)</p>			
<p>KT-LALED-5CC-1-F-KIT</p> <p>Feed Kit, J-Box Mount 5" Circular White. Includes (1) 15' aircraft cable with 2 piece cable coupler, (1) 5" power feed circular canopy, (1) Crossbar with 1/4-20 screw, (1) 18/5 SJT sized strain relief, (5) cable ties, (NO POWER CORD INCLUDED)</p>	<p>KT-LALED-5CC-1-NF-KIT</p> <p>Non-Feed Kit, J-Box / Stud Mount 5" Circular White. Includes (1) 15' aircraft cable with 2 piece cable coupler, (1) 5" non-feed circular canopy, (1) Crossbar with 1/4-20 screw</p>	<p>KT-LALED-2CC-1-NF-KIT</p> <p>Non-Feed Kit, Drywall / Stud Mount 2" Circular White. Includes (1) 15' aircraft cable with cable coupler, (1) 2" non-feed circular canopy, (1) 1/4-20 Toggle Bolt Assembly, (1) 1/4-20 Lag Screw</p>	
<p>KT-LALED-2CC-2-NF-KIT</p> <p>Non-Feed Kit, T-Bar Mount 2" Circular White. Includes (1) 15' aircraft cable with 2 piece cable coupler, (1) 2" non-feed circular canopy, (1) Drop Ceiling Clip / Stud</p>	<p>KT-LALED-5CC-2-NF-KIT</p> <p>Non-Feed Kit, T-Bar Mount 5" Circular White. Includes (1) 15' aircraft cable with 2 piece cable coupler, (1) 5" non-feed circular canopy, (1) Drop Ceiling Clip / Stud</p>	<p>KT-LALED-2CC-3-NF-KIT</p> <p>Non-Feed Kit, Masonry Mount 2" Circular White. Includes (1) 15' aircraft cable with 2 piece cable coupler, (1) 2" non-feed circular canopy, (1) 1/4-20 Stud (LAG SHIELD NOT INCLUDED)</p>	

Square

<p>KT-LALED-SC-UNV-NF-KIT / A</p> <p>Universal Canopy Cover Non-Feed Kit, J-Box/Stud/T-Bar/Drywall/Masonry Mount 2" & 5" Square Covers 2 piece & 1 piece coupler White. No aircraft cable included (re-use aircraft cable supplied with each fixture)</p>			
<p>KT-LALED-5SC-1-F-KIT</p> <p>Feed Kit, J-Box Mount 5" Square White. Includes (1) 15' aircraft cable with 2 piece cable coupler, (1) 5" power feed square canopy, (1) Crossbar with 1/4-20 screw, (1) 18/5 SJT sized strain relief, (5) cable ties, (NO POWER CORD INCLUDED)</p>	<p>KT-LALED-5SC-1-NF-KIT</p> <p>Non-Feed Kit, J-Box / Stud Mount 5" Square White. Includes (1) 15' aircraft cable with 2 piece cable coupler, (1) 5" non-feed square canopy, (1) Crossbar with 1/4-20 screw</p>	<p>KT-LALED-2SC-1-NF-KIT</p> <p>Non-Feed Kit, Drywall / Stud Mount 2" Square White. Includes (1) 15' aircraft cable with cable coupler, (1) 2" non-feed square canopy, (1) 1/4-20 Toggle Bolt Assembly, (1) 1/4-20 Lag Screw</p>	
<p>KT-LALED-2SC-2-NF-KIT</p> <p>Non-Feed Kit, T-Bar Mount 2" Square White. Includes (1) 15' aircraft cable with 2 piece cable coupler, (1) 2" non-feed square canopy, (1) Drop Ceiling Clip / Stud</p>	<p>KT-LALED-5SC-2-NF-KIT</p> <p>Non-Feed Kit, T-Bar Mount 5" Square White. Includes (1) 15' aircraft cable with 2 piece cable coupler, (1) 5" non-feed square canopy, (1) Drop Ceiling Clip / Stud</p>	<p>KT-LALED-2SC-3-NF-KIT</p> <p>Non-Feed Kit, Masonry Mount 2" Square White. Includes (1) 15' aircraft cable with 2 piece cable coupler, (1) 2" non-feed square canopy, (1) 1/4-20 Stud (LAG SHIELD NOT INCLUDED)</p>	

Black Fixtures & Shapes



Power and Color Select

CATALOG NUMBER	NOMINAL SIZE	SELECTABLE WATTAGE	LUMENS	SELECTABLE CCT	EFFICACY	INPUT VOLTAGE	DIMMABLE	DLC	CRI
KT-LALED20PS-2A-8CSF-VDIM-B	2' Linear	20W	2620	2700K 3000K 3500K 4000K 5000K	131 lm/W	120-277V	0-10V	Yes	>80
		15W	1965						
		12W	1575						
KT-LALED30PS-3A-8CSF-VDIM-B	3' Linear	30W	3930	2700K 3000K 3500K 4000K 5000K	131 lm/W	120-277V	0-10V	Yes	>80
		23W	3015						
		18W	2360						
KT-LALED40PS-4A-8CSF-VDIM-B	4' Linear	40W	5240	2700K 3000K 3500K 4000K 5000K	131 lm/W	120-277V	0-10V	Yes	>80
		30W	3930						
		25W	3275						
KT-LALED80PS-8A-8CSF-VDIM-B	8' Linear	80W	10480	2700K 3000K 3500K 4000K 5000K	131 lm/W	120-277V	0-10V	Yes	>80
		60W	7860						
		50W	6550						

Power and Color Select

CATALOG NUMBER	FIXTURE SHAPE	SELECTABLE WATTAGE	MAXIMUM LUMENS	SELECTABLE CCT	EFFICACY	INPUT VOLTAGE	DIMMABLE	DLC	CRI
KT-LALED25PS-LA-8CSF-VDIM-B	L Shape	26W	3250	2700K 3000K 3500K 4000K 5000K	125 lm/W	120-277V	0-10V	Yes	>80
		16W	4625						
		20W	6250						
KT-LALED37PS-TA-8CSF-VDIM-B	T Shape	37W	3250	2700K 3000K 3500K 4000K 5000K	125 lm/W	120-277V	0-10V	Yes	>80
		30W	4625						
		23W	6250						
KT-LALED37PS-XA-8CSF-VDIM-B	X Shape	50W	3250	2700K 3000K 3500K 4000K 5000K	125 lm/W	120-277V	0-10V	Yes	>80
		38W	4625						
		30W	6250						





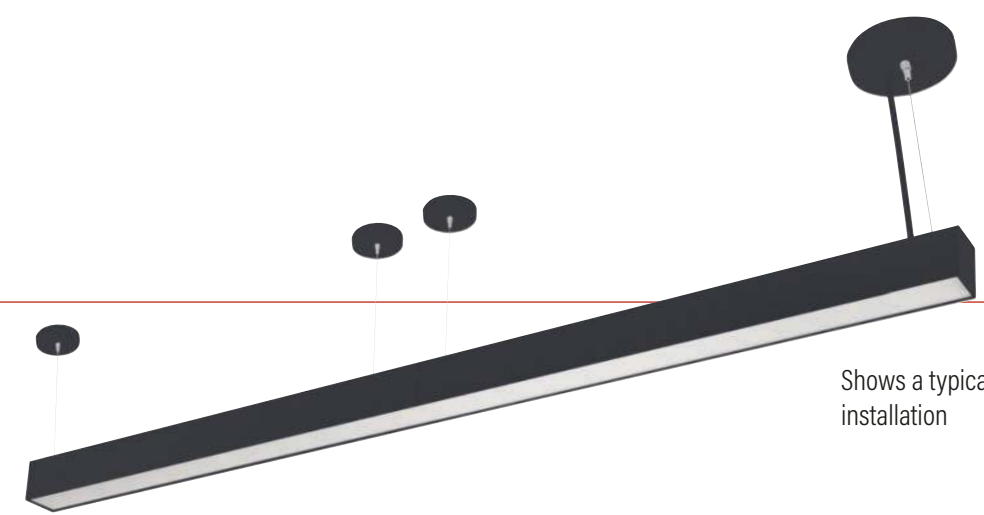

Black Canopy Kits

Create a streamlined, modern look with Keystone canopy kits. Our hardware and accessories add the finishing touch to your Linta installation.









Shows a typical installation

Round

 <p>KT-LALED-5CC-1-F-KIT-B</p> <p>Feed Kit, J-Box Mount 5" Circular Black. Includes (1) 15' aircraft cable with 2 piece cable coupler, (1) 5" power feed circular canopy, (1) Crossbar with 1/4-20 screw, (1) 18/5 SJT sized strain relief, (5) cable ties (NO POWER CORD INCLUDED)</p>	 <p>KT-LALED-5CC-1-NF-KIT-B</p> <p>Non-Feed Kit, J-Box / Stud Mount 5" Circular Black. Includes (1) 15' aircraft cable with 2 piece cable coupler, (1) 5" non-feed circular canopy, (1) Crossbar with 1/4-20 screw</p>	 <p>KT-LALED-2CC-1-NF-KIT-B</p> <p>Non-Feed Kit, Drywall / Stud Mount 2" Circular Black. Includes (1) 15' aircraft cable with cable coupler, (1) 2" non-feed circular canopy, (1) 1/4-20 Toggle Bolt Assembly, (1) 1/4-20 Lag Screw</p>
 <p>KT-LALED-2CC-2-NF-KIT-B</p> <p>Non-Feed Kit, T-Bar Mount 2" Circular Black. Includes (1) 15' aircraft cable with 2 piece cable coupler, (1) 2" non-feed circular canopy, (1) Drop Ceiling Clip / Stud</p>	 <p>KT-LALED-5CC-2-NF-KIT-B</p> <p>Non-Feed Kit, T-Bar Mount 5" Circular Black. Includes (1) 15' aircraft cable with 2 piece cable coupler, (1) 5" non-feed circular canopy, (1) Drop Ceiling Clip / Stud</p>	 <p>KT-LALED-2CC-3-NF-KIT-B</p> <p>Non-Feed Kit, Masonry Mount 2" Circular Black. Includes (1) 15' aircraft cable with 2 piece cable coupler, (1) 2" non-feed circular canopy, (1) 1/4-20 Stud (LAG SHIELD NOT INCLUDED)</p>

Square

 <p>KT-LALED-5SC-1-F-KIT-B</p> <p>Feed Kit, J-Box Mount 5" Square Black. Includes (1) 15' aircraft cable with 2 piece cable coupler, (1) 5" power feed square canopy, (1) Crossbar with 1/4-20 screw, (1) 18/5 SJT sized strain relief, (5) cable ties, (NO POWER CORD INCLUDED)</p>	 <p>KT-LALED-5SC-1-NF-KIT-B</p> <p>Non-Feed Kit, J-Box / Stud Mount 5" Square Black. Includes (1) 15' aircraft cable with 2 piece cable coupler, (1) 5" non-feed square canopy, (1) Crossbar with 1/4-20 screw</p>	 <p>KT-LALED-2SC-1-NF-KIT-B</p> <p>Non-Feed Kit, Drywall / Stud Mount 2" Square Black. Includes (1) 15' aircraft cable with cable coupler, (1) 2" non-feed square canopy, (1) 1/4-20 Toggle Bolt Assembly, (1) 1/4-20 Lag Screw</p>
 <p>KT-LALED-2SC-2-NF-KIT-B</p> <p>Non-Feed Kit, T-Bar Mount 2" Square Black. Includes (1) 15' aircraft cable with 2 piece cable coupler, (1) 2" non-feed square canopy, (1) Drop Ceiling Clip / Stud</p>	 <p>KT-LALED-5SC-2-NF-KIT-B</p> <p>Non-Feed Kit, T-Bar Mount 5" Square Black. Includes (1) 15' aircraft cable with 2 piece cable coupler, (1) 5" non-feed square canopy, (1) Drop Ceiling Clip / Stud</p>	 <p>KT-LALED-2SC-3-NF-KIT-B</p> <p>Non-Feed Kit, Masonry Mount 2" Square Black. Includes (1) 15' aircraft cable with 2 piece cable coupler, (1) 2" non-feed square canopy, (1) 1/4-20 Stud (LAG SHIELD NOT INCLUDED)</p>

Mounting Kits & Accessories

Wall Mounts

CATALOG NUMBER	COLOR	DESCRIPTION
KT-LALED-2A-WM-KIT	White	Wall mounting kit for 2' fixtures. Includes standard length 5-wire wiring harness
KT-LALED-2A-WM-KIT-B	Black	
KT-LALED-3A-WM-KIT	White	Wall mounting kit for 3' fixtures. Includes standard length 5-wire wiring harness
KT-LALED-3A-WM-KIT-B	Black	
KT-LALED-4A-WM-KIT	White	Wall mounting kit for 4' fixtures. Includes standard length 5-wire wiring harness
KT-LALED-4A-WM-KIT-B	Black	
KT-LALED-8A-WM-KIT	White	Wall mounting kit for 5' fixtures. Includes standard length 5-wire wiring harness
KT-LALED-8A-WM-KIT-B	Black	
KT-LALED-A-LBR-WM		Linking bracket for wall mount end-to-end daisy-chain connections. (Optional)
KT-LALED-WH-WM-20-KIT		Extended length wire harness for wall mount kit, 20', 5-wire. For use with daisy-chain wall mount installations with a center power feed location
KT-LALED-WH-WM-20EM-KIT		Extended length wire harness for wall mount kit, 20', 6-wire. For use with daisy-chain wall mount installations with a center power feed location for emergency backup needs (extra conductor for switch leg)



Surface Mounts

CATALOG NUMBER	COLOR	DESCRIPTION
KT-LALED-2A-SM-KIT	White	Surface mounting kit for 2' fixtures
KT-LALED-2A-SM-KIT-B	Black	
KT-LALED-3A-SM-KIT	White	Surface mounting kit for 3' fixtures
KT-LALED-3A-SM-KIT-B	Black	
KT-LALED-4A-SM-KIT	White	Surface mounting kit for 4' fixtures
KT-LALED-4A-SM-KIT-B	Black	
KT-LALED-8A-SM-KIT	White	Surface mounting kit for 8' fixtures
KT-LALED-8A-SM-KIT-B	Black	

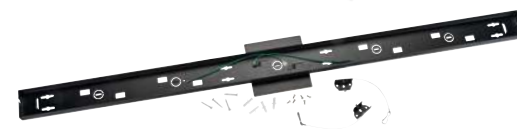

Recessed Mounts

CATALOG NUMBER	COLOR	DESCRIPTION
KT-LALED-2A-RM-KIT	White	Recessed mounting kit for 2' fixtures in drywall ceilings
KT-LALED-3A-RM-KIT		Recessed mounting kit for 3' fixtures in drywall ceilings
KT-LALED-4A-RM-KIT		Recessed mounting kit for 4' fixtures in drywall ceilings
KT-LALED-8A-RM-KIT		Recessed mounting kit for 8' fixtures in drywall ceilings



Cord and Wire Harness

CATALOG NUMBER	COLOR	DESCRIPTION
KT-CS-NP-10-18/5-W /LA	White	10' input power cord, 18/5, 300V SJT, White. Includes power quick-connects and strain relief optimized for KT-LALED fixtures
KT-CS-NP-10-18/5-W /LA-B	Black	
KT-LALED-WH-MD-KIT		Wire harness kit for multi-directional power feed. Used in conjunction with an input power cord when the feed location is in center of run



Sensors

CATALOG NUMBER	COLOR	DESCRIPTION
KTSL-FC2-12V-SM-PIR	White	Bluetooth mesh wireless low-voltage individual fixture controller for SmartLoop system
KT-LALED-A-EC-SL	White	End cap for SmartLoop wireless control sensor
KT-LALED-A-EC-SL-B	Black	



Lens

CATALOG NUMBER	DESCRIPTION
KT-LALED-A-32S-LENS-KIT	Monolithic lens for KT-LALED fixtures. 32 ft long roll.



Additional Accessories

CATALOG NUMBER	COLOR	DESCRIPTION
KT-LALED-CANOPY-1-KIT	White	Pair of 5" circular canopy covers, with included hardware to install (1) fixture: 1 power feed, 1 non-power feed. For use with standard J-box / stud mount installations. Compatible with aircraft cable hardware included with each fixture
KT-LALED-CANOPY-1-KIT-B	Black	
KT-LALED-A-EC-EM	White	End cap for emergency backup test button
KT-LALED-A-EC-EM-B	Black	
KT-JBOX-4TB		4" octagon box / T-bar box. (3.5" across flats) Includes punch-outs to slide over T-bar grid

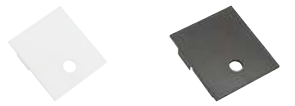

Louver Kits

Hexagonal Louver Kits

CATALOG NUMBER	DESCRIPTION	
KT-LALED-2A-LVR-1-KIT	Hexagonal Louver Kit for 2ft Series A Linear Arch Fixtures. Louver compatible end caps sold separately	
KT-LALED-3A-LVR-1-KIT	Hexagonal Louver Kit for 3ft Series A Linear Arch Fixtures. Louver compatible end caps sold separately	
KT-LALED-4A-LVR-1-KIT	Hexagonal Louver Kit for 4ft Series A Linear Arch Fixtures. Louver compatible end caps sold separately	
KT-LALED-8A-LVR-1-KIT	Hexagonal Louver Kit for 8ft Series A Linear Arch Fixtures. Louver compatible end caps sold separately	

Hexagonal Louver Kits

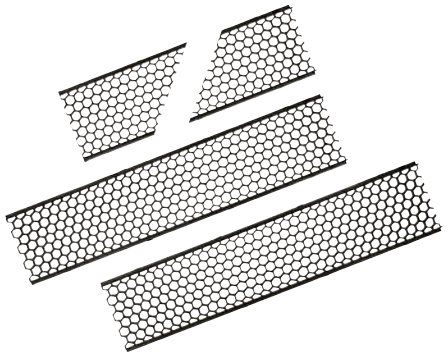
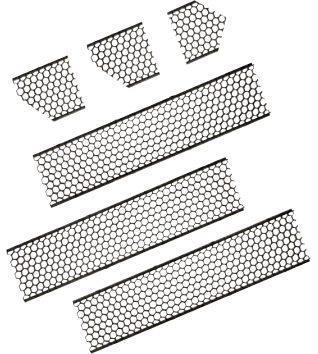
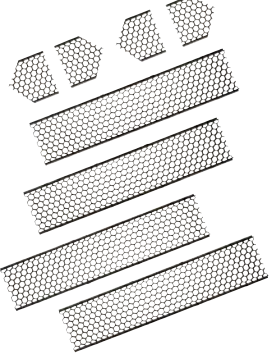
CATALOG NUMBER	DESCRIPTION	
KT-LALED-LA-LVR-1-KIT	Hexagonal Louver Kit for L Shape Series A Linear Arch Fixtures. Louver compatible end caps sold separately	
KT-LALED-TA-LVR-1-KIT	Hexagonal Louver Kit for T Shape Series A Linear Arch Fixtures. Louver compatible end caps sold separately	
KT-LALED-XA-LVR-1-KIT	Hexagonal Louver Kit for X Shape Series A Linear Arch Fixtures. Louver compatible end caps sold separately	

Louver Kits

Straight Blade Louver Kits

CATALOG NUMBER	DESCRIPTION	
KT-LALED-2A-LVR-2-KIT	Straight Blade Louver Kit for 2ft Series A Linear Arch Fixtures. Louver compatible end caps sold separately	
KT-LALED-3A-LVR-2-KIT	Straight Blade Louver Kit for 3ft Series A Linear Arch Fixtures. Louver compatible end caps sold separately	
KT-LALED-4A-LVR-2-KIT	Straight Blade Louver Kit for 4ft Series A Linear Arch Fixtures. Louver compatible end caps sold separately	
KT-LALED-8A-LVR-2-KIT	Straight Blade Louver Kit for 8ft Series A Linear Arch Fixtures. Louver compatible end caps sold separately	

Straight Blade Louver Kits

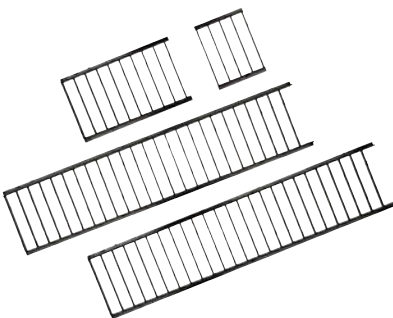
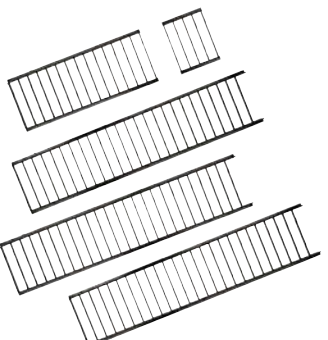
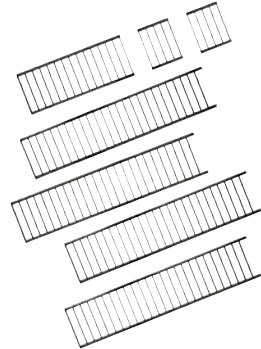
CATALOG NUMBER	DESCRIPTION	
KT-LALED-LA-LVR-2-KIT	Straight Blade Louver Kit for L Shape Series A Linear Arch Fixtures. Louver compatible end caps sold separately	
KT-LALED-TA-LVR-2-KIT	Straight Blade Louver Kit for T Shape Series A Linear Arch Fixtures. Louver compatible end caps sold separately	
KT-LALED-XA-LVR-2-KIT	Straight Blade Louver Kit for X Shape Series A Linear Arch Fixtures. Louver compatible end caps sold separately	

Louver Kit End Caps

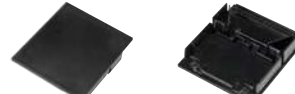
CATALOG NUMBER	COLOR	DESCRIPTION	
KT-LALED-A-EC-LVR	White	End Cap for Series A Linear Arch Fixtures for use with all Louver Kits	
KT-LALED-A-EC-LVR-B	Black	End Cap for Series A Linear Arch Fixtures for use with all Louver Kits	



LAMPS | FIXTURES | POWER SUPPLIES | CONTROLS

Keystone Technologies Philadelphia, PA 800.464.2680 kestonetech.com