



KT-WPLED120-L1-8CSB-VDIM-W

TRADITIONAL NON-CUTOFF LED WALL PACK

DESCRIPTION

Traditional 120W Non-Cutoff LED Wall Pack | 120-277V Input | 3000-5000K | Large-Size Housing | White Finish | Glass Lens

APPLICATION

Building mount for exterior illumination (perimeters, pathways, loading docks, and other general security lighting requirements)



10 YEAR
LIMITED WARRANTY

PRODUCT FEATURES

- Keystone Color Select technology (3000/4000/5000K)
- Traditional design that matches appearance and light distribution pattern of legacy HID fixtures. Optimized for one-for-one replacements
- Heavy duty die cast aluminum housing with (5) 1/2" threaded conduit hubs: (1) on back and (1) on all four sides
- Powered by Keystone 0-10V dimming LED drivers
- Built-in dusk-to-dawn photocell behind translucent 3/4" threaded plug with anti-yellowing agent
- Borosilicate glass lens diffuses light source and provides uniform distribution
- Covers footprint of large HID wallpacks
- Ambient operating temperature: -40°C/-40°F to 50°C/122°F
- UL Certified for wet locations; IP65 rated
- Fixture impact rating IK06
- Power Factor: >0.95
- THD: <20%
- LED chip lifetime: L70 >100,000 hrs @ 25°C/77°F ambient fixture temperature
- Meets FCC Part 15, Part B, Class A standards for conducted and radiated emissions
- **Compatible with Keystone LED Emergency Backups. See Accessories page for more details**

PRODUCT SPECIFICATIONS

Catalog Number	Wattage	Selectable CCT*	Lumens	Lumens Below 90°	Efficacy	Input Voltage	Dimming	CRI	Rated Life	Legacy Equivalent	Housing Color
KT-WPLED120-L1-8CSB-VDIM-W	120W	3000K	16410	14770	137 lm/W	120-277V	0-10V	>80	50,000 hrs	400W MH	White
		4000K	17865	16075	149 lm/W						
		5000K	16900	15210	141 lm/W						

* Color Uniformity: CCT (Correlated Color Temperature) range as per guidelines outlined in ANSI C78.377-2017



KT-WPLED120-L1-8CSB-VDIM-W

TRADITIONAL NON-CUTOFF LED WALL PACK

PHYSICAL SPECIFICATIONS

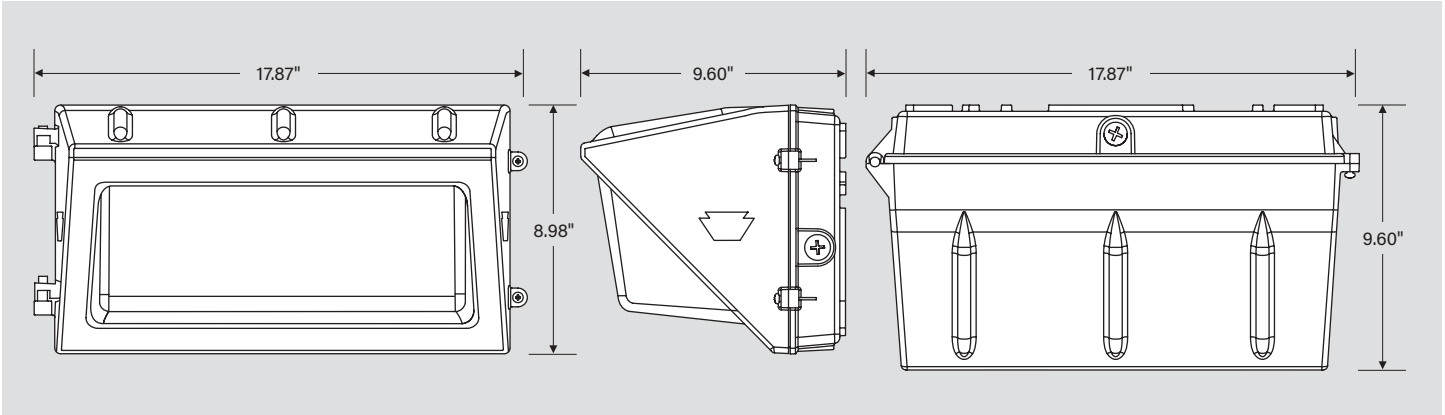

GENERAL SETUP INSTRUCTIONS

GENERAL WIRING DIAGRAM

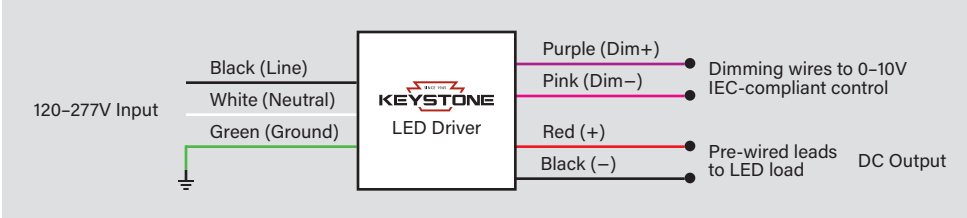

Caution: Before installing, make certain that AC power to the fixture is off.

Caution: The electrical rating of this product is 120-277V. Installer must confirm that there is 120-277V at the fixture before installation.

PHOTOCELL ENABLE / DISABLE

This fixture is equipped with a dusk-to-dawn photocell behind the translucent knock-out (KO) cover. Adjust the dip switch to enable (ON) or disable (OFF) the photocell function (see illustrations to the right). Fixture comes pre-set with photocell enabled unless otherwise noted.

COLOR SELECT (CCT) ADJUSTMENT

This fixture is equipped with Color Select technology. There is an adjustable dip switch behind the translucent knock-out (KO) cover to change CCT between 5000K, 4000K, and 3000K (see illustrations to the right). Fixture comes preset at 5000K unless otherwise noted.

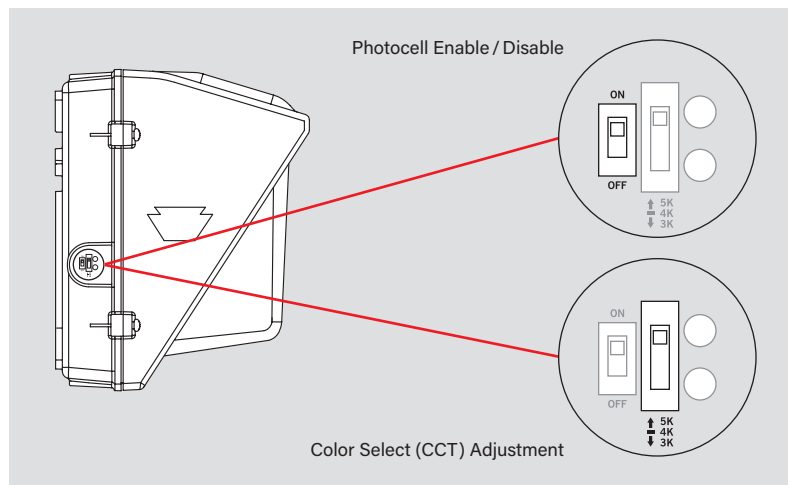

KT-WPLED120-L1-8CSB-VDIM-W

TRADITIONAL NON-CUTOFF LED WALL PACK

PHOTOMETRIC SPECIFICATIONS

ISOCANDELA PLOT

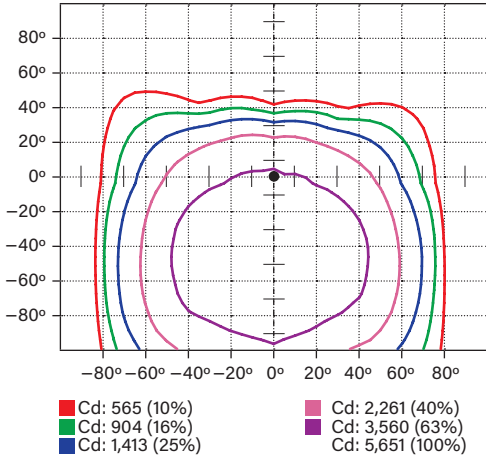

LUMINOUS INTENSITY DISTRIBUTION

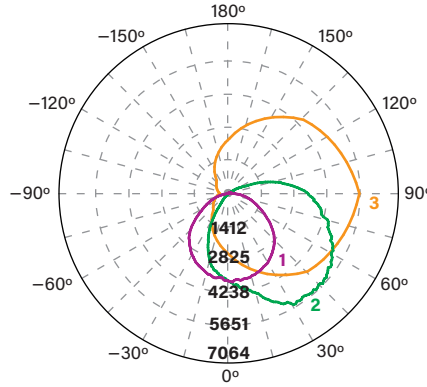

Average diffuse angle (50%): 112.3°

- 1 Violet C0 - C180
- 2 Green C90 - C270
- 3 Orange G46

Unit: cd

FLUX DISTRIBUTION

Zone	Lumens	% Luminaire
Forward Light	11,932 lm	71.6%
0°-30°	1,998 lm	12.0%
30°-60°	5,312 lm	31.9%
60°-80°	3,365 lm	20.2%
80°-90°	1,257 lm	7.5%
Back Light	2,803 lm	17.0%
0°-30°	1,280 lm	7.7%
30°-60°	1,273 lm	7.6%
60°-80°	250 lm	1.5%
80°-90°	39 lm	0.2%
Up Light	1,877 lm	11.3%
90°-100°	899 lm	5.4%
100°-180°	979 lm	5.9%

BUG* Rating

Asymmetrical Luminaire Types

Type I, II, III, IV B3 U4 G5

Quadrilateral Symmetrical Luminaire Types

Type V, Area Light B3 U4 G5

* Backlight, Uplight, Glare

MOUNTING

Side view

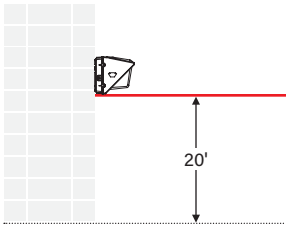

LIGHT DISTRIBUTION PATTERN

Isometric view from above; Luminaire mounted at 20'

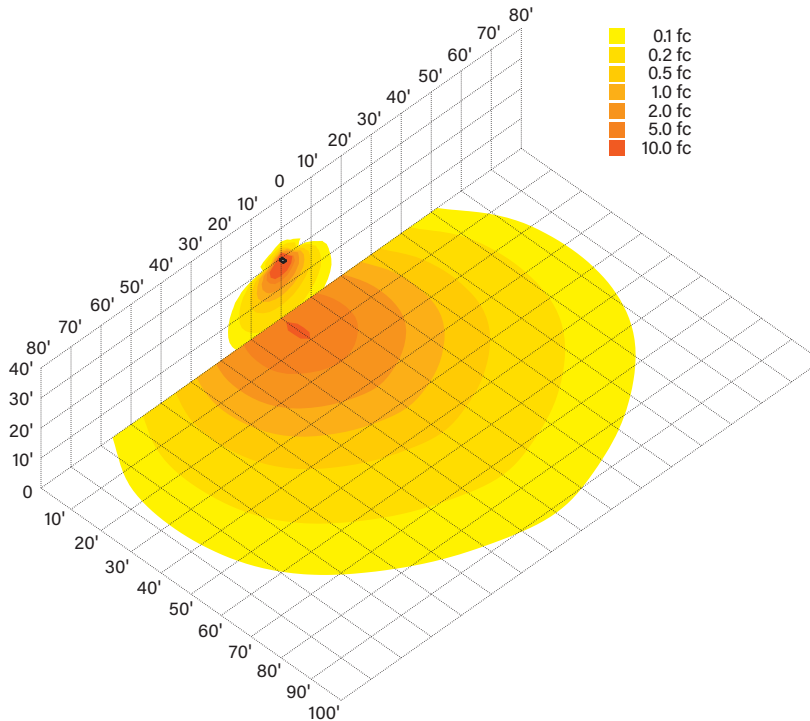

KT-WPLED120-L1-8CSB-VDIM-W
TRADITIONAL NON-CUTOFF LED WALL PACK

ACCESSORIES

SENSORS

Factory-Installable OR Field-Installable (field-installable purchased separately)

✓	SUFFIX*	CATALOG NUMBER	DESCRIPTION	UPC	EASY CODE
	/MW3	KTS-MW3-UV-KO-K1	Microwave Sensor Kit, Includes 120-277V input to 12V DC convertor & 12V input sensor head, IP65. Bi-Level Control with Adjustable Hold Time, Dim Level and Standby Time. Installs via standard 1/2in KO	843654134147	BKG-51



* For factory installation of accessory, add suffix to fixture part number (see ordering examples and instructions on last page of spec sheet).

CORD SETS

Factory-Installable OR Field-Installable (field-installable purchased separately)

✓	SUFFIX*	CATALOG NUMBER	DESCRIPTION	UPC	EASY CODE
	/515P6	KT-CS-515P-6-18/3	Cord set for high bay; 125V NEMA 5-15P; straight blade plug; 6' SJTOW cable; 18/3 wire	843654140124	UKH-26
	/L515P6	KT-CS-L515P-6-16/3	Cord set for high bays; 250V NEMA L5-15P; twist lock plug; 6' SJTOW cable; 16/3 wire	843654140186	POC-82

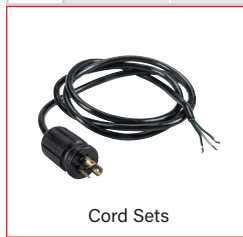

* For factory installation of accessory, add suffix to fixture part number (see ordering examples and instructions on last page of spec sheet).
Note: For cord sets not listed here, please contact your Keystone sales rep.

EMERGENCY BACKUP

Factory-Installable OR Field-Installable (field-installable purchased separately)

✓	SUFFIX*	CATALOG NUMBER	DESCRIPTION	UPC	EASY CODE
	/EM12	KT-EMRG-LED-12C-1200	LED Emergency Back-Up, 12W Constant Wattage Design. Approx 1200 Lumens. 120-277V Input. Remote Compact Battery Pack. CEC T20 Compliant.	843654103112	OJQ-32
	-	KT-EMRG-LED2-TS-IP65	IP65 Rated Wet Location Test Switch for 5W and 12W CEC Compliant LED Emergency Packs	843654130019	MDB-29

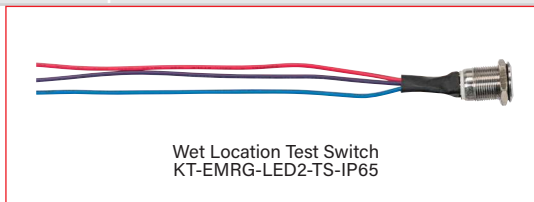

* For factory installation of accessory, add suffix to fixture part number (see ordering examples and instructions on last page of spec sheet).
† Factory installation of emergency backup units will automatically include any relevant mounting bracket.

(Accessories continued on next page)



KT-WPLED120-L1-8CSB-VDIM-W

TRADITIONAL NON-CUTOFF LED WALL PACK

ACCESSORIES (continued)

SURGE PROTECTORS

Factory-Installable OR Field-Installable (field-installable purchased separately)

✓	SUFFIX*	CATALOG NUMBER	DESCRIPTION	UPC	EASY CODE
	/10KV	KTSP-10KV-C	External Surge Protector, compact design. Parallel Wiring, 120-277V Input, Max Peak Protection (10KV, 10KA)	843654129204	BUU-26



** For factory installation of accessory, add suffix to fixture part number (see ordering examples and instructions on last page of spec sheet).*



KT-WPLED120-L1-8CSB-VDIM-W

TRADITIONAL NON-CUTOFF LED WALL PACK

ORDERING INFORMATION

CATALOG NUMBER	PACK QTY.	UPC	EASY CODE	DLC PRODUCT ID
KT-WPLED120-L1-8CSB-VDIM-W	1	843654133805	GSD-04	P8P3XGCZ

CATALOG NUMBER BREAKDOWN

KT-WPLED120-L1-8CSB-VDIM-W

1	2	3	4	5	6	7	8	9	10	11
1 Keystone Technologies	2 Fixture Type	3 LED Lamp	4 Wattage	5 Size	6 Style	7 CRI	8 Color	9 Color Select Designation	10 Dimming	11 Housing Color
	WP Wallpack			L Large	1 Non-Cutoff	8 >80	CS Color Select	B 3000/4000/5000K	VDIM 0-10V	W White
2 Fixture Type		3 LED Lamp				7 CRI				
3 LED Lamp										
4 Wattage										
5 Size										
6 Style										
7 CRI										
8 Color Select										
9 Color Select Designation										
10 Dimming										
11 Housing Color										
12 Accessories (see below for details)										

ORDERING EXAMPLES

FIXTURE WITH MULTIPLE FACTORY-INSTALLED ACCESSORIES*

KT-WPLED120-L1-8CSB-VDIM-W /MW3/515P6/EM12

FIXTURE WITH SINGLE FACTORY-INSTALLED ACCESSORY

KT-WPLED120-L1-8CSB-VDIM-W /MW3

FIXTURE WITH NO FACTORY-INSTALLED ACCESSORIES

KT-HBLED60-1.5F-840-VDIM-W

KEYSTONE FIXTURE

CATALOG NUMBER
KT-WPLED120-L1-8CSB-VDIM-W

SENSORS

✓	SUFFIX	CATALOG NUMBER
✓	/MW3	KTS-MW3-UV-KO-K1

CORD SETS

✓	SUFFIX	CATALOG NUMBER
✓	/515P6	KT-CS-515P-6-18/3

EMERGENCY BACKUP

✓	SUFFIX	CATALOG NUMBER
✓	/EM12	KT-EMRG-LED-12C-1200

* When ordering more than one factory-installed accessory, use multiple suffixes as shown in the ordering examples above.
 Note: All accessories can also be ordered separately for field installation using just their regular Catalog Number, UPC, or Easy Code.