

KT-SWLED25PS-2A-8CSA-VDIM-P

LED STAIRWELL FIXTURE

DESCRIPTION

2' LED Stairwell Fixture | 120-277V Input | Frosted Lens |
0-10V Dimming | Premium Series

APPLICATION

Used in commercial and retail applications. Ideal for use
in stairwells, corridors, and hallways.



10 YEAR
LIMITED WARRANTY

PRODUCT FEATURES

- Features Keystone Power Select technology (25/20/15W). Adjust power between 25/20/15W, changing lumen output to set high end trim.
- Features Keystone Color Select technology (3500/4000/5000K)
- Powered by Keystone 0-10V dimming LED drivers, dimmable to 10%
- Post-painted steel body; PMMA lens
- Smooth, diffused lens for an even appearance
- UL Listed 1598: Suitable for damp locations
- Ambient operating temperature: $-20^{\circ}\text{C}/-4^{\circ}\text{F}$ to $50^{\circ}\text{C}/122^{\circ}\text{F}$
- Compatible with Keystone SmartSafe emergency LED drivers: KT-EMRG-LED-5C-500 or KT-EMRG-LED-12C-1200 are optimal for fixture level installation
- Includes integrated ultrasonic dimming occupancy sensor
- LED lifetime: L70 >100,000 hours @ 25°C ambient fixture temperature
- THD: < 20%
- Power factor: > 0.95

PRODUCT SPECIFICATIONS

Catalog Number	Wattage	CCT	Lumen Output	Efficacy	Input Voltage	CRI	Dimming	Lifetime
KT-SWLED25PS-2A-8CSA-VDIM-P	25W	3500K	3,100	124 lm/W	120-277V	> 80	0-10V Dim-to-Off	50,000 hrs
		4000K	3,125	125 lm/W				
		5000K	3,150	126 lm/W				
	20W	3500K	2,540	127 lm/W				
		4000K	2,560	128 lm/W				
		5000K	2,580	129 lm/W				
	15W	3500K	1,950	130 lm/W				
		4000K	1,965	131 lm/W				
		5000K	1,980	132 lm/W				

PHYSICAL SPECIFICATIONS

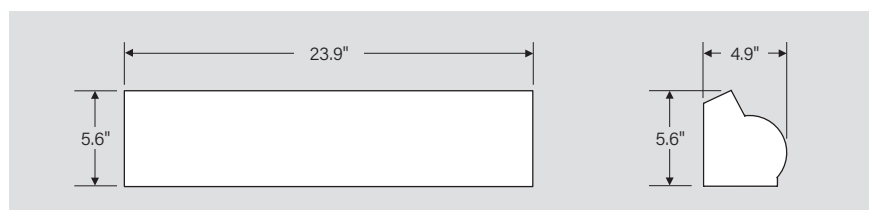



KT-SWLED25PS-2A-8CSA-VDIM-P

LED STAIRWELL FIXTURE

SENSOR INFORMATION

Occupancy Sensing: 0–10V dimmer connects to 0–10V control on the LED driver. When motion is detected the sensor will bring lighting up to 100% lumen output. When no motion is detected for the length of selected Time Delay, the sensor will send a signal to dim lighting to a specific level set by the end-user.

Test Mode: Test Mode sets the time delay to five seconds and runs for 5 minutes. LED flashes 2 times to indicate Test Mode started. After 5 minutes (or push the Test Mode button again), LED flashes 3 times, the sensor returns to the selected time delay. During test mode, full output when triggered, and dimming level reflects the dip switch setting.

Relay Control: Two additional High and Low motion outputs can be used to control relays or other control circuitry.

Sensor Type	Ultrasonic occupancy sensor
Input Voltage Current Consumption	12–24VDC 45mA sensor
0–10V Output	100mA, up to 50 LED sink drivers
High	Vin–2.5V 100mA source
Low	100mA sink current
Mounting Height	Fixture wall mount or ceiling mount at 8–12' (2.4–3.7m) height
[Low/Med/High] Max Range* (Wall-Mounted)	13' (4.0m) / 18' (5.5m) / 35' (10.7m)
Time Delays (TD1)	1 min, 5 min, 20 min
Operating Temperature	–30°C/–22°F to 70°C/158°F
Storage Temperature	–40°C/–40°F to 80°C/176°F
Relative Humidity	90–95% non-condensing at 30°C/86°F
Color	White
Warranty	5 years

**Results may vary based on mounting height, angle, floor material, and line-of-sight.*

SETTINGS ADJUSTMENTS

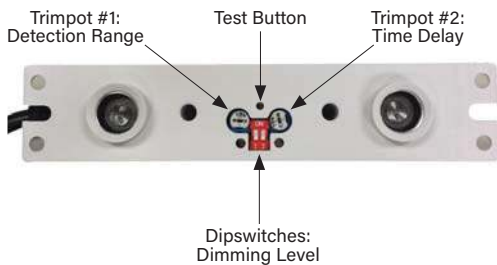

Dipswitch 1	Dipswitch 2	DIM Level
OFF	OFF	OFF
OFF	ON	10%
ON	OFF	25%
ON	ON	50%

LIGHTING COVERAGE AND DISTRIBUTION PATTERN

- Photometric layout for general reference only
- Stairwell fixture wall-mounted at 7.9 ft
- Aerial view
- Grid dimension: 1.64 sq ft (0.5 sq m)

- High Coverage
- Medium Coverage
- Low Coverage

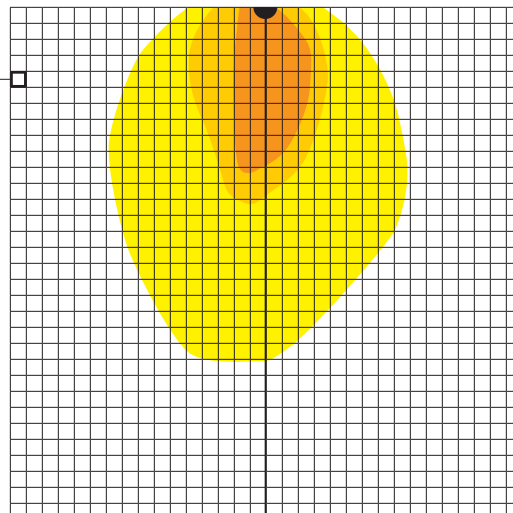



KT-SWLED25PS-2A-8CSA-VDIM-P

LED STAIRWELL FIXTURE

EMERGENCY PACK WIRING DIAGRAM

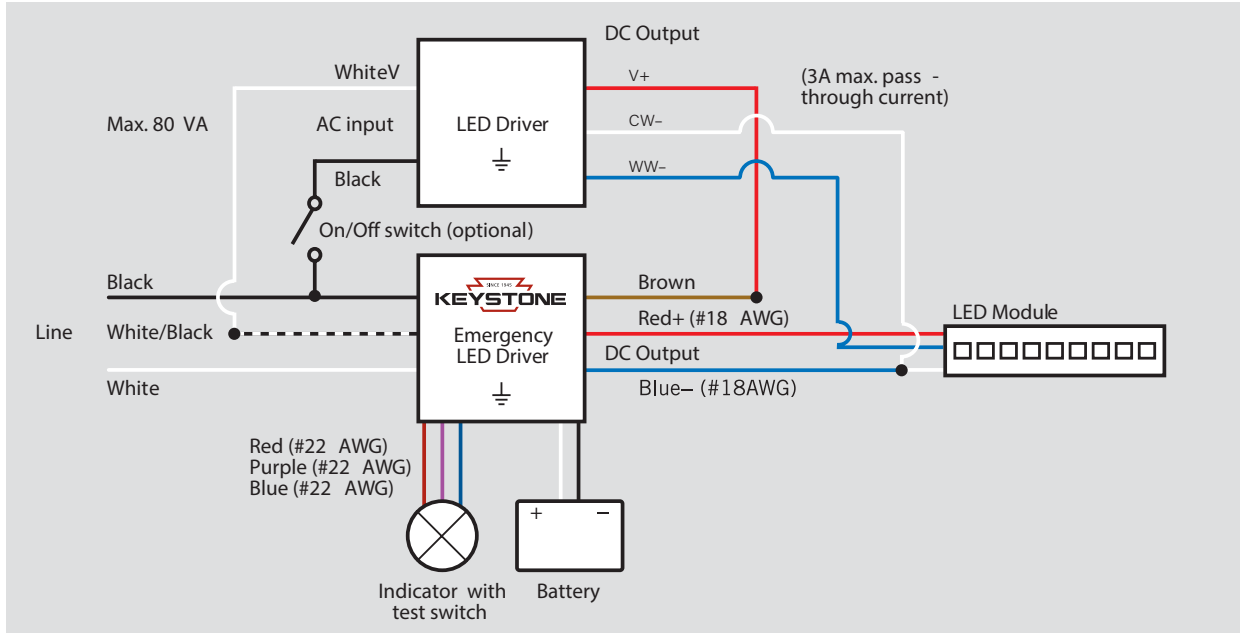

SENSOR SPECIFICATIONS

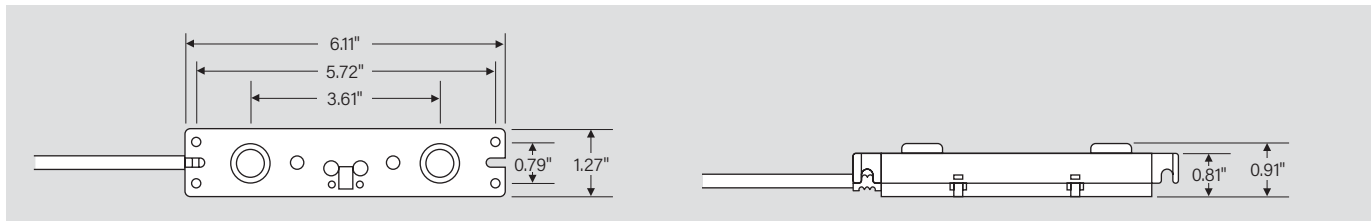



KT-SWLED25PS-2A-8CSA-VDIM-P

LED STAIRWELL FIXTURE

ACCESSORIES

CORD SETS

Factory-Installable OR Field-Installable (field-installable purchased separately)

✓	SUFFIX*	CATALOG NUMBER	DESCRIPTION	UPC	EASY CODE
	/515P6	KT-CS-515P-6-18/3	Cord set for high bay; 125V NEMA 5-15P; straight blade plug; 6' SJTOW cable; 18/3 wire	843654140124	UKH-26
	/L715P10	KT-CS-L715P-10-16/3	Cord set for high bays; 277V NEMA L7-15P; twist lock plug; 10' SJTOW cable; 16/3 wire	843654140131	SFV-88
	/L615P10	KT-CS-L615P-10-16/3	Cord set for high bays; 250V NEMA L6-15P; twist lock plug; 10' SJTOW cable; 16/3 wire	843654140148	ZQS-05
	/L515P10	KT-CS-L515P-10-16/3	Cord set for high bays; 125V NEMA L5-15P; twist lock plug; 10' SJTOW cable; 16/3 wire	843654140155	GVH-22
	/L715P6	KT-CS-L715P-6-16/3	Cord set for high bays; 277V NEMA L7-15P; twist lock plug; 6' SJTOW cable; 16/3 wire	843654140162	DVU-44
	/L615P6	KT-CS-L615P-6-16/3	Cord set for high bays; 250V NEMA L6-15P; twist lock plug; 6' SJTOW cable; 16/3 wire	843654140179	LCW-66
	/L515P6	KT-CS-L515P-6-16/3	Cord set for high bays; 125V NEMA L5-15P; twist lock plug; 6' SJTOW cable; 16/3 wire	843654140186	POC-82
	/NP10	KT-CS-NP-10-16/3	Cord for high bays; no plug; inners 1/2" strip on both ends; 10' SJTOW cable; 16/3 wire	843654140193	YOH-90
	/NP6	KT-CS-NP-6-16/3	Cord for high bays; no plug; inners 1/2" strip on both ends; 6' SJTOW cable; 16/3 wire	843654140216	HUB-73
	/NP15	KT-CS-NP-15-16/3	Cord for high bays; no plug; inners 1/2" strip on both ends; 15' SJTOW cable; 16/3 wire	843654140209	EYD-18

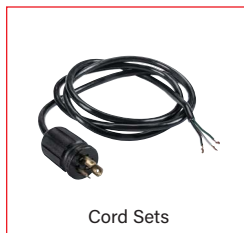

* For factory installation of accessory, add suffix to fixture part number (see ordering examples and instructions on last page of spec sheet).
Note: For cord sets not listed here, please contact your Keystone sales rep.

EMERGENCY BACKUP

Factory-Installable OR Field-Installable (field-installable purchased separately)

✓	SUFFIX*	CATALOG NUMBER	DESCRIPTION	UPC	EASY CODE
	/EM5†	KT-EMRG-LED-5C-500	5W, 500 lumen Smart Safe emergency backup, CEC T20 Compliant	843654103099	JTR-48
	/EM12†	KT-EMRG-LED-12C-1200	12W, 1200 lumen Smart Safe emergency backup, CEC T20 Compliant	843654103112	OJQ-32

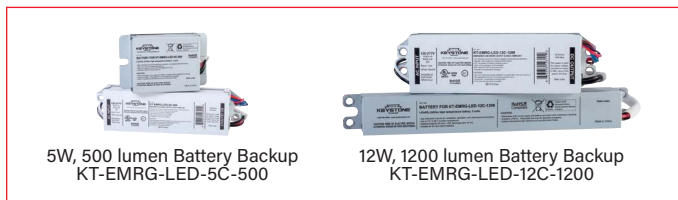

* For factory installation of accessory, add suffix to fixture part number (see ordering examples and instructions on last page of spec sheet).
 † Factory installation of emergency backup units will automatically include any relevant mounting bracket.

(Accessories continued on next page)



KT-SWLED25PS-2A-8CSA-VDIM-P

LED STAIRWELL FIXTURE

ACCESSORIES (continued)

MOUNTS AND BRACKETS

Factory-Installable OR Field-Installable (field-installable purchased separately)

✓	SUFFIX*	CATALOG NUMBER	DESCRIPTION	UPC	EASY CODE
	/WG	KT-SWLED-WG-1-KIT	Wire Guard for LED Stairwell Fixtures. Thick steel wire and premium white powdercoat construction.	843654132464	PIT-99
	/CP	KT-SWLED-CP	Replacement Cover Plate for Stairwell Fixture, used to cover Sensor Trimpot	843654157290	SHW-24

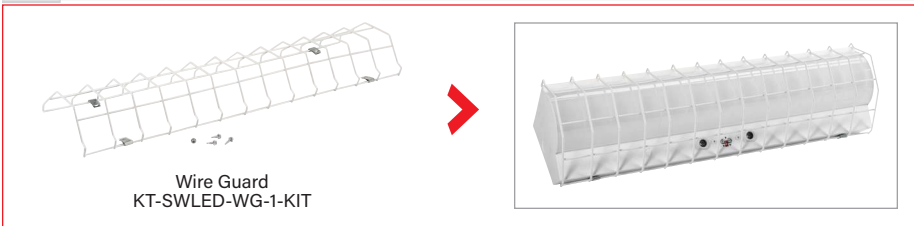

* For factory installation of accessory, add suffix to fixture part number (see ordering examples and instructions on last page of spec sheet).

STEP-DOWN TRANSFORMERS

Factory-Installable OR Field-Installable (field-installable purchased separately)

✓	SUFFIX*	CATALOG NUMBER	DESCRIPTION	UPC	EASY CODE
	/480†	KTAT-250-480-277 /SF	Fully enclosed, single flex step-down transformer for LED high bay fixtures (250VA or lower)	843654102931	XIM-17



* For factory installation of accessory, add suffix to fixture part number (see ordering examples and instructions on last page of spec sheet).

† Factory installation of step-down transformer units will automatically include any relevant mounting bracket.

* Step-down transformers cannot be ordered in conjunction with standard SJTOW cord set options (contact Keystone sales rep for available custom options if needed).



KT-SWLED25PS-2A-8CSA-VDIM-P

LED STAIRWELL FIXTURE

ORDERING INFORMATION

CATALOG NUMBER	PACK QUANTITY	UPC	EASY CODE	DLC PRODUCT ID
KT-SWLED25PS-2A-8CSA-VDIM-P	1	843654132440	OBG-40	PTTTLA44

CATALOG NUMBER BREAKDOWN

KT-SWLED25PS-2A-8CSA-VDIM-P

1	2	3	4	5	6	7	8	9	10	11
1 Keystone Technologies	2 LED Stairwell Fixture	3 Wattage	4 Power Select	5 2' Nominal Length	6 Light Distribution Type	7 80 CRI	8 Color Select	9 Color Select Designation	10 0-10V Dimming	11 Premium Series
								A	3500K, 4000K, 5000K	

ORDERING EXAMPLES

FIXTURE WITH MULTIPLE FACTORY-INSTALLED ACCESSORIES*

KT-SWLED25PS-2A-8CSA-VDIM-P /L715P6/EM5/WG



FIXTURE WITH MULTIPLE FACTORY-INSTALLED ACCESSORIES*

KT-SWLED25PS-2A-8CSA-VDIM-P /EM5/WG/480

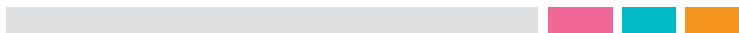

FIXTURE WITH TWO FACTORY-INSTALLED ACCESSORIES*

KT-SWLED25PS-2A-8CSA-VDIM-P /480

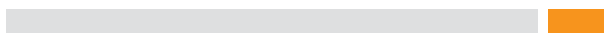

FIXTURE WITH NO FACTORY-INSTALLED ACCESSORIES

KT-SWLED25PS-2A-8CSA-VDIM-P

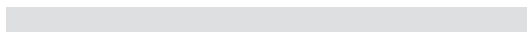

* When ordering more than one factory-installed accessory, use multiple suffixes as shown in the ordering examples above.
 Note: All accessories can also be ordered separately for field installation using just their regular Catalog Number, UPC, or Easy Code.

KEYSTONE FIXTURE	
CATALOG NUMBER	
KT-SWLED25PS-2A-8CSA-VDIM-P	

CORD SETS	
SUFFIX	CATALOG NUMBER
✓ /L715P6	KT-CS-L715P-6-16/3

EMERGENCY BACKUP	
SUFFIX	CATALOG NUMBER
✓ /EM5	KT-EMRG-LED-5C-500

MOUNTS AND BRACKETS	
SUFFIX	CATALOG NUMBER
✓ /WG	KT-SWLED-WG-1-KIT

STEP-DOWN TRANSFORMERS	
SUFFIX	CATALOG NUMBER
✓ /480	KTAT-250-480-277 /SF

Note: Step-down transformers cannot be ordered in conjunction with standard SJTOW cord set options (contact Keystone sales rep for available custom options if needed).