



KT-LED82P-V-8xx-D

2-PIN LED LAMP



DESCRIPTION

8W 2-Pin LED Lamp | 2700K, 3000K, 3500K, 4000K, 5000K | ≥83 CRI

LAMP TYPE: Compact
BULB TYPE: 2-Pin LED
BASE TYPE: G24d, G24q, GX24q
WATTAGE: 8W
COLOR TEMPERATURE: 2700K, 3000K, 3500K, 4000K, 5000K
COLOR RENDERING INDEX (CRI): ≥83
WARRANTY: 5 Years



PRODUCT FEATURES

- ****Replaces 26W/32W/42W G24d, G24q, GX24q CFL Lamps****
 - 50,000+ Hour Lifetime
 - Approximately 50% More Energy Efficient than Traditional CFL Lamps
 - Environmentally Friendly: No Mercury Used
 - Instant Startup
 - Frosted Lens Eliminates Pixelation
 - Integral Driver, Eliminates the Need for External Driver or Ballast
 - UL Recognized and UL Classified
 - Operating Temperature: -20°C/-4°F to 45°C/113°F
 - Up to 5x Longer Life than Traditional CFL Lamps
 - Vertical Orientation
 - Suitable for use in fully enclosed fixture
 - Minimum lamp compartment dimensions: 12cm x 15cm
- *G24q-5/6/7 and Gx24q-5/6/7 not compatible

OPERATING SPECIFICATIONS

ELECTRICAL CHARACTERISTICS

Input Voltage	Lamp Wattage	Power Factor	System Wattage
120-277V	8W	>0.9	8W

PHOTOMETRIC CHARACTERISTICS

Color Temperature (CCT)	2700K	3000K	3500K	4000K	5000K
Luminous Flux	900 lm	900 lm	900 lm	950 lm	950 lm
Color Rendering Index (CRI)	≥83	≥83	≥83	≥83	≥83
Bare Lamp Efficacy	113 lm/W	113 lm/W	113 lm/W	119 lm/W	119 lm/W
Beam Angle	>120°	>120°	>120°	>120°	>120°

RATED LIFE

L70 (Hours)	50,000
-------------	--------

POLAR CANDELA DISTRIBUTION

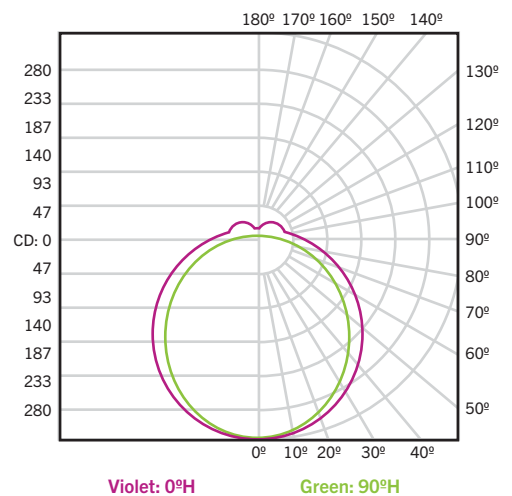



KT-LED82P-V-8xx-D

2-PIN LED LAMP

WIRING

BYPASS MAGNETIC BALLAST WITH 1 LAMP

BEFORE

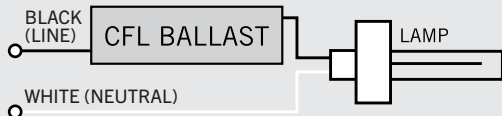

AFTER

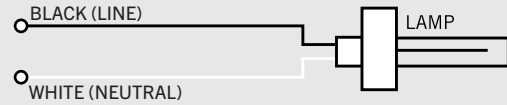

BYPASS ELECTRONIC BALLAST WITH 1 LAMP

BEFORE

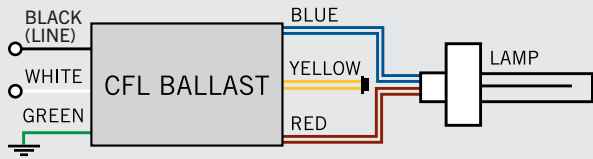

AFTER

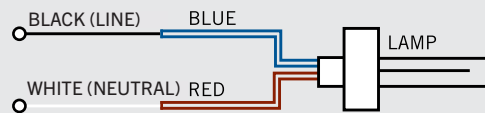

BYPASS MAGNETIC BALLAST WITH 2 LAMPS

BEFORE

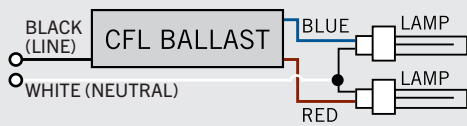

AFTER

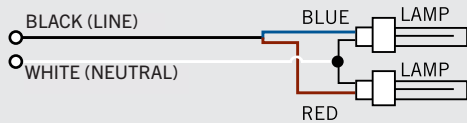

BYPASS ELECTRONIC BALLAST WITH 2 LAMPS

BEFORE

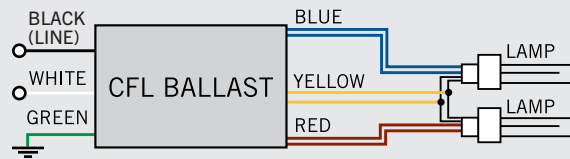

AFTER

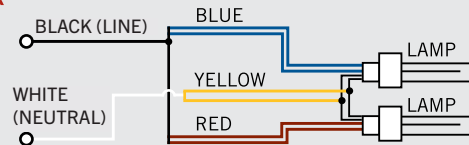

PHYSICAL CHARACTERISTICS

LAMP DIMENSIONS

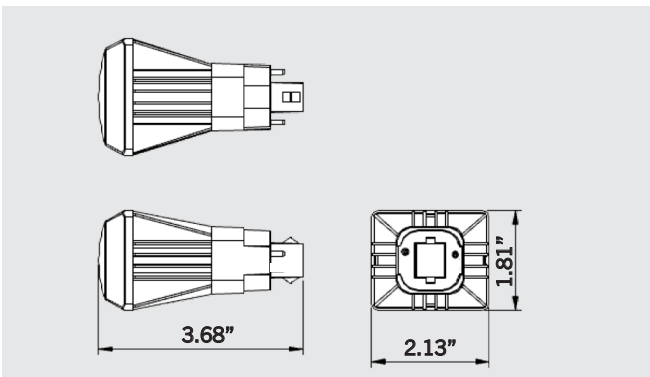



KT-LED82P-V-8xx-D

2-PIN LED LAMP

ORDERING INFORMATION

ORDER CODE	PACK QTY.	EASY CODE	UPC
KT-LED82P-V-827-D-DP	50	FGO-45	890949012741
KT-LED82P-V-830-D-DP	50	IWR-13	890949012758
KT-LED82P-V-835-D-DP	50	XHT-14	890949012765
KT-LED82P-V-840-D-DP	50	KVM-23	890949012772
KT-LED82P-V-850-D-DP	50	ISC-98	890949012789

CATALOG NUMBER BREAKDOWN

KT-LED82P-V-8XX-D

1 2 3 4 5 6 7 8

- 1 Keystone Technologies
- 2 LED Lamp
- 3 Wattage
- 4 Lamp Type
- 5 Orientation
- 6 80 CRI
- 7 Color Temperature
- 8 Direct Drive series