

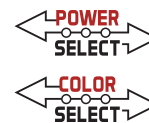

XFIT



KT-WPLED35PS-S3-8CSB-VDIM

ADJUSTABLE WALL PACK

DESCRIPTION

0° - 90° Adjustable LED Wall Pack | Power Select | Color Select | 120-277V | Bronze Housing

APPLICATION

Commercial wall mount applications for outdoor illumination (alleys, pathways, landscape lighting)



10 YEAR
LIMITED WARRANTY



PRODUCT FEATURES

- Keystone Power Select technology (35/25/15W)
- Keystone Color Select technology (3000/4000/5000K)
- 0° - 90° field adjustable light positioning to illuminate areas missed by traditional forward throw wall packs
- Heavy duty, die cast aluminum housing with enhanced performance and reliability
- Built in dusk to dawn photocell behind translucent 3/4" threaded plug with antiyellowing agent
- Powered by Keystone 0-10V dimming LED drivers
- Ambient operating temperature: -40°C/-40°F - 50°C/122°F
- UL certified, IP65 rated
- THD: < 20%
- LED chip lifetime: L70 > 100,000 hrs @ 25°C/77°F ambient fixture temperature
- Meets FCC Part 15, Part B, Class A standards for conducted and radiated emissions
- TAA options available, see Ordering Information below for details

PRODUCT SPECIFICATIONS

Catalog Number	Wattage	CCT	Lumens	Efficacy	Dimming	CRI	Input Voltage	Photocell	Housing Color	Rated Life	Legacy Equivalent
KT-WPLED35PS-S3-8CSB-VDIM	35W	3000K	4375	125 lm/W	0-10V	>80	120-277V	Included	Bronze	50,000 hrs	150W MH
		4000K	5075	145 lm/W							
		5000K	4725	135 lm/W							
	25W	3000K	3375	135 lm/W							
		4000K	3750	150 lm/W							
		5000K	3625	145 lm/W							
	15W	3000K	2178	145 lm/W							
		4000K	2325	155 lm/W							
		5000K	2250	150 lm/W							

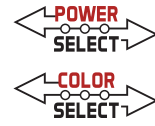

KT-WPLED35PS-S3-8CSB-VDIM

ADJUSTABLE WALL PACK

PHYSICAL SPECIFICATIONS

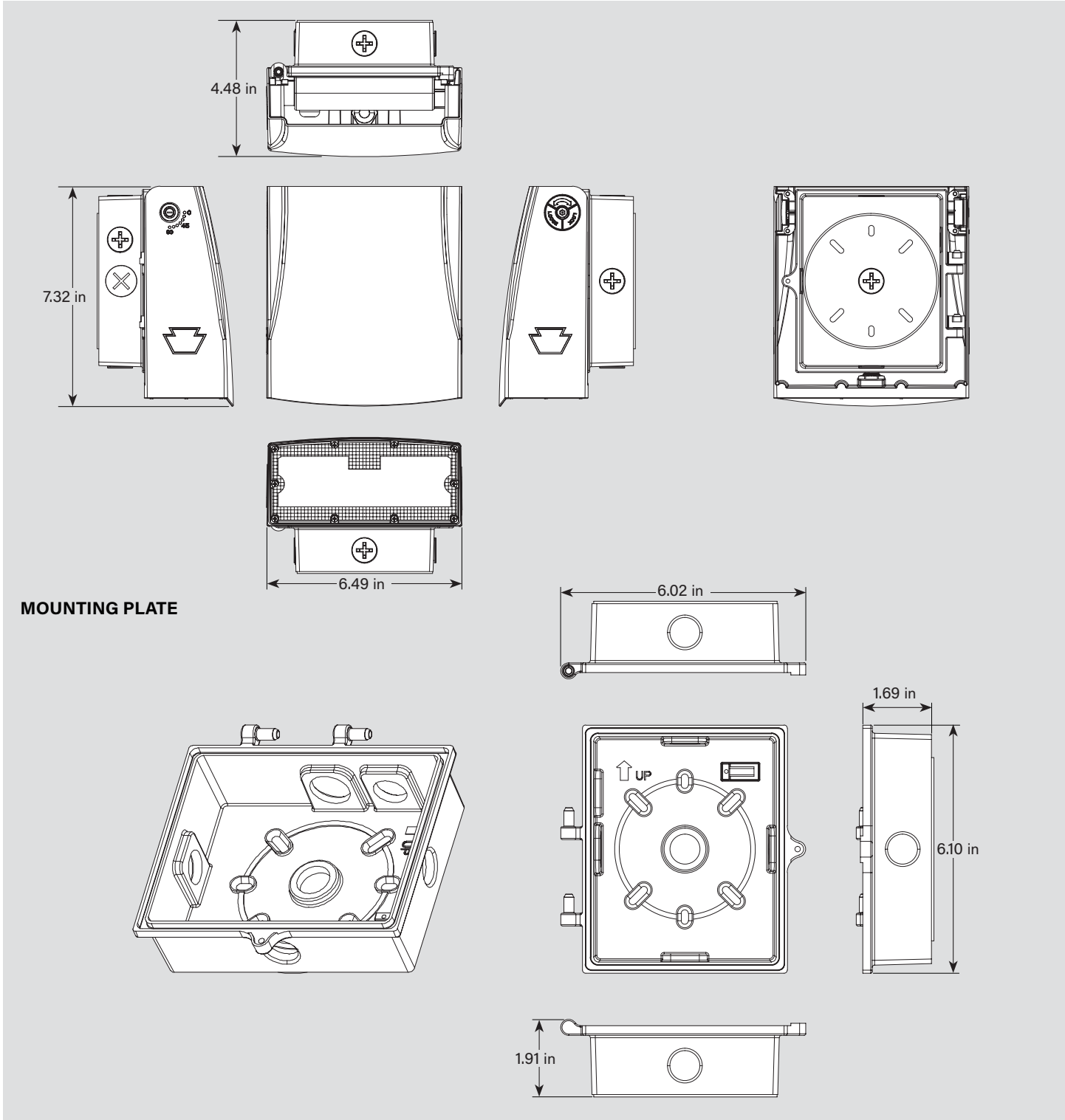

MOUNTING PLATE

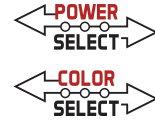

KT-WPLED35PS-S3-8CSB-VDIM

ADJUSTABLE WALL PACK

GENERAL SETUP INSTRUCTIONS

GENERAL WIRING DIAGRAM

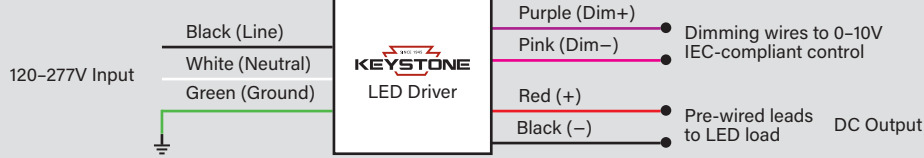

Caution: Before installing, make certain that AC power to the fixture is off.

Caution: The electrical rating of this product is 120-277V. Installer must confirm that there is 120-277V at the fixture before installation.

Note: *In accordance with NEC-20 410.69 2022, all 0-10V negative wires have been updated from gray to pink. Please contact Keystone for details

ANGLE ADJUSTMENT INSTRUCTIONS

1. Loosen the screw on the side of the housing using an Allen wrench.
2. Adjust housing to desired setting, 0° - 90° in 15° intervals.
3. Tighten the screw on the side of the housing using the Allen wrench in Step 1.

PHOTOCELL AND CCT ADJUSTMENT

This fixture is equipped with a dusk to dawn photocell behind the translucent knockout (KO). Enable or disable the photocell by removing the cap and adjusting the dip switch to your desired setting. Fixture comes preset with photocell enabled. This fixture is also equipped with Keystone Color Select technology. The CCT dip switch is located in the same KO as the photocell. Remove the cap and adjust to your desired setting. This fixture comes preset to 5000K.

WATTAGE ADJUSTMENT

This fixture is equipped with Keystone Power Select technology. The adjustable knob is located in the driver compartment. See instructions below on how to access. Fixture comes preset to either 75W or 35W, depending on model ordered.

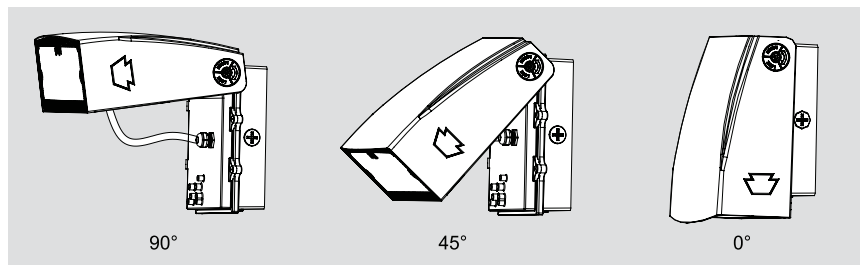
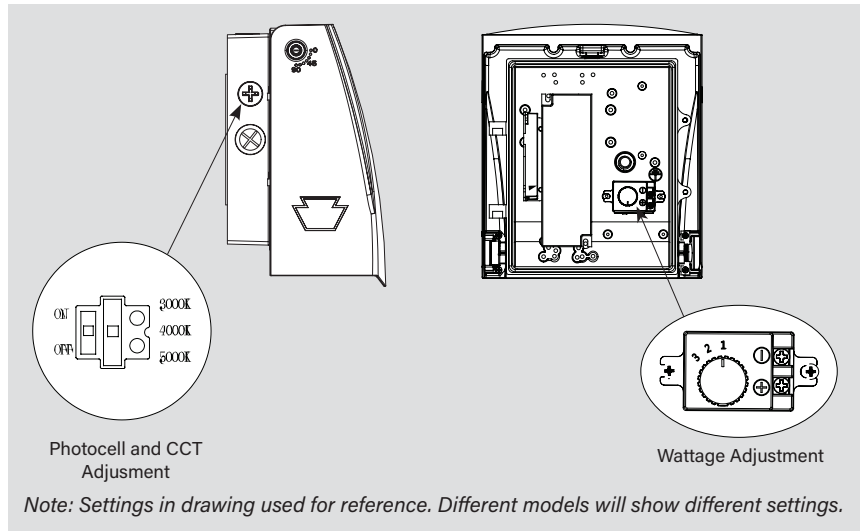

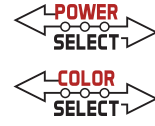

KT-WPLED35PS-S3-8CSB-VDIM

ADJUSTABLE WALL PACK

PHOTOMETRICS SPECIFICATIONS

Full cutoff wall pack
35W 5000K
Building mounted 15'

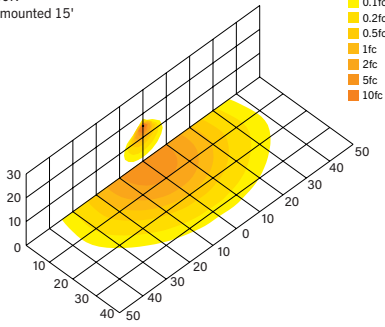

Full cutoff wall pack
25W 5000K
Building mounted 15'

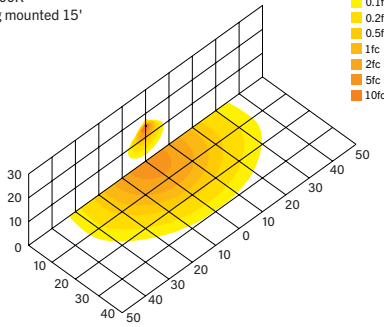

Full cutoff wall pack
15W 5000K
Building mounted 15'

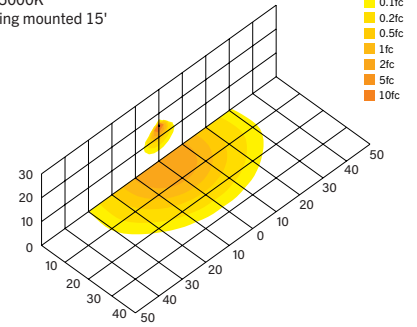

Luminous Intensity Distribution Curve

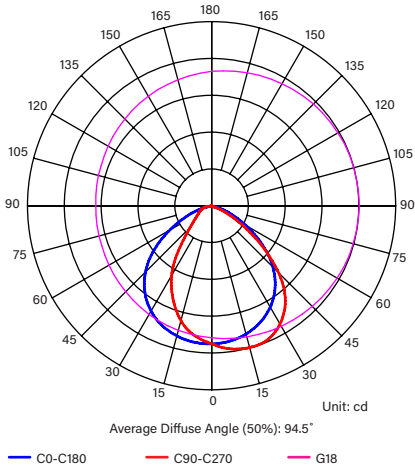

Isocandela (Rectangle)

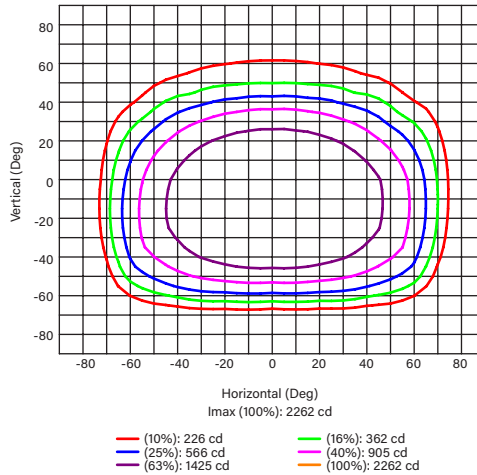

ZONE	LUMENS	% LAMP LUMENS
FORWARD LIGHT	2938	60.3
FL (0° - 30°)	904	18.6
FM (30° - 60°)	1674	34.4
FH (60° - 80°)	352	7.2
FVH (80° - 90°)	9	0.2

BACK LIGHT	1886	38.7
BL (0° - 30°)	768	15.8
BM (30° - 60°)	917	18.8
BH (60° - 80°)	175	3.6
BVH (80° - 90°)	23	0.5

UP LIGHT	49	1.0
UL (90° - 100°)	5	0.1
UH (100° - 180°)	44	0.9

TRAPPED LIGHT	NA	NA
----------------------	-----------	-----------

BUG (Backlight, Uplight, Glare) Rating Base On TM-15-07	
Asymmetrical Luminaire Types (Type I, II, III, IV)	B2 U2 G1
Quadrilateral Symmetrical Luminaire Types (Type V, Area Light)	B2 U2 G1

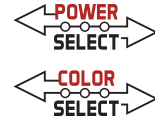

KT-WPLED35PS-S3-8CSB-VDIM

ADJUSTABLE WALL PACK

ACCESSORIES

CORD SETS

Factory-Installable OR Field-Installable (field-installable purchased separately)

✓	SUFFIX*	CATALOG NUMBER	DESCRIPTION	UPC	EASY CODE
	/515P6	KT-CS-515P-6-18/3	Cord set for high bay; 125V NEMA 5-15P; straight blade plug; 6' SJTOW cable; 18/3 wire	843654140124	UKH-26
	/L515P6	KT-CS-L515P-6-16/3	Cord set for high bays; 250V NEMA L5-15P; twist lock plug; 6' SJTOW cable; 16/3 wire	843654140186	POC-82



Cord Sets

* For factory installation of accessory, add suffix to fixture part number (see ordering examples and instructions on last page of spec sheet).
Note: For cord sets not listed here, please contact your Keystone sales rep.

EMERGENCY BACKUP

Field-Installable (purchased separately)

✓	SUFFIX*	CATALOG NUMBER	DESCRIPTION	UPC	EASY CODE
	-	KT-EMRG-LED-12C-1200	LED Emergency Back-Up, 12W Constant Wattage Design. Approx 1200 Lumens. 120-277V Input. Remote Compact Battery Pack. CEC T20 Compliant.	843654103112	OJQ-32
	-	KT-EMRG-LED2-TS-IP65	IP65 Rated Wet Location Test Switch for 5W and 12W CEC Compliant LED Emergency Packs	843654130019	MDB-29

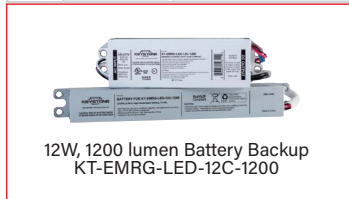

12W, 1200 lumen Battery Backup
KT-EMRG-LED-12C-1200

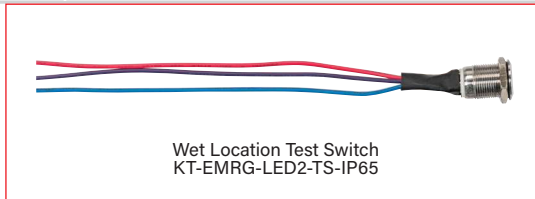

Wet Location Test Switch
KT-EMRG-LED2-TS-IP65

Note: emergency back up must be installed in remote junction box. Emergency pack will not fit inside of fixture.

SURGE PROTECTORS

Factory-Installable OR Field-Installable (field-installable purchased separately)

✓	SUFFIX*	CATALOG NUMBER	DESCRIPTION	UPC	EASY CODE
	/10KV	KTSP-10KV-C	External Surge Protector, compact design. Parallel Wiring, 120-277V Input, Max Peak Protection (10KV, 10KA)	843654129204	BUU-26



External Surge Protector
KTSP-10KV-C

* For factory installation of accessory, add suffix to fixture part number (see ordering examples and instructions on last page of spec sheet).

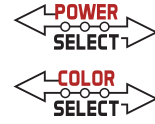

KT-WPLED35PS-S3-8CSB-VDIM

ADJUSTABLE WALL PACK

ORDERING INFORMATION

CATALOG NUMBER	UPC	EASY CODE	DLC PRODUCT ID
KT-WPLED35PS-S3-8CSB-VDIM	843654141848	ZRH-81	S-WN3FD9
KT-WPLED35PS-S3-8CSB-VDIM /TAA	843654158778	SRE-94	

CATALOG NUMBER BREAKDOWN

KT-WPLED35PS-S3-8CSB-VDIM

1	2	3	4	5	6	7	8	9	10	11	12
1 Keystone Technologies	2 Wall Pack	3 LED	4 Max Wattage	5 Power Select	6 Size	7 Style	8 CRI	9 Color Select	10 Color Select Designation	11 0-10V Dimming	12 TAA Compliant
					S	Adjustable Full Cutoff	8		B		/TAA
								>80	3000/4000/5000K		Made in Mexico

ORDERING EXAMPLES

FIXTURE WITH TWO FACTORY-INSTALLED ACCESSORIES*

KT-WPLED35PS-S3-8CSB-VDIM /515P6/10KV

FIXTURE WITH ONE FACTORY-INSTALLED ACCESSORY

KT-WPLED35PS-S3-8CSB-VDIM /515P6

FIXTURE WITH NO FACTORY-INSTALLED ACCESSORIES

KT-WPLED35PS-S3-8CSB-VDIM

KEYSTONE FIXTURE

CATALOG NUMBER
KT-WPLED35PS-S3-8CSB-VDIM

CORD SETS

✓ SUFFIX	CATALOG NUMBER
/515P6	KT-CS-515P-6-18/3

SURGE PROTECTORS

✓ SUFFIX	CATALOG NUMBER
/10KV	KTSP-10KV-C

* When ordering more than one factory-installed accessory, use multiple suffixes as shown in the ordering examples above.
Note: All accessories can also be ordered separately for field installation using just their regular Catalog Number, UPC, or Easy Code.