

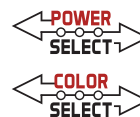

XFIT



KT-VTLED44PS-4A-8CSA-VDIM

LED VAPORTIGHT FIXTURE

DESCRIPTION

4' LED Vaportight Fixture | 120-277V Input | Frosted Lens | 0-10V Dimming

APPLICATION

Used for commercial and industrial rugged or outdoor applications



10 YEAR
LIMITED WARRANTY

PRODUCT FEATURES

- Features Keystone Color Select technology. Adjust CCT between 3500K/4000K/5000K
- Features Keystone Power Select technology. Adjust power between 44W/28W/18W
- Traditional design, narrow body, Vapor Tight fixture, suitable for rugged, demanding applications
- Powered by Keystone 120-277V, 0-10V dimming LED driver, 10% minimum
- Smooth, diffused, impact resistant polycarbonate lens provides even lit appearance
- Compatible with Keystone motion and occupancy sensors, featuring high-end trim and daylight sensing.
- Stainless steel, tamper resistant lens clips (screws not included)
- Includes mounting hardware, cordgrip, and hole plug for out-of-the-box installation
- Compatible with Keystone SmartSafe emergency backups, max of 30°C ambient operating temperature with emergency pack installed
- NEMA 4X rated enclosure
- IP66 Ingress Protection
- IK10 Impact Rating
- Ambient operating temperature: -40°C/-40°F to 50°C/122°F
- LED chip lifetime: L70 >100,000 hours @ 25°C/77°F ambient fixture temperature
- PF: > 0.95
- THD: < 20%
- UL Certified for Wet Locations
- ETL Sanitation Listed NSF/ANSI Standard 2 - Food Equipment, Splash Zone (Not for Direct Food Zone)
- DesignLights Consortium® (DLC) qualified product. Not all product variations listed on this page are DLC premium. Visit <https://qpl.designlights.com> to confirm if the product meets the DLC Standard or Premium designation

Disclaimer: Not suitable for car wash applications or other applications with similar heavy pressure spray and/or splashing considerations with cleaning chemicals such as petrochemical detergents (aka soaps), chlorine, and/or humidity typically above 85% for prolonged periods

PRODUCT SPECIFICATIONS

Catalog Number	Input Voltage	Wattage	Color Temperature	Lumens	Efficacy	Rated Life	CRI	Power Factor
KT-VTLED44PS-4A-8CSA-VDIM*	120-277V	44W	3500K	5,764	131 lm/W	50,000 hrs	>80	>0.9
			4000K	5,808	132 lm/W			
			5000K	5,852	133 lm/W			
		28W	3500K	3,892	139 lm/W			
			4000K	3,920	140 lm/W			
			5000K	3,948	141 lm/W			
		18W	3500K	2,556	142 lm/W			
			4000K	2,574	143 lm/W			
			5000K	2,592	144 lm/W			

ONE CATALOG NUMBER WITH 9 DIFFERENT OPTIONS

* Preset to highest lumen output (44W / 5000K)

* Color Uniformity: CCT (Correlated Color Temperature) range as per guidelines outlined in ANSI C78.377-2017.

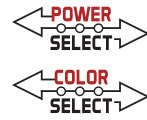

KT-VTLED44PS-4A-8CSA-VDIM

LED VAPORTIGHT FIXTURE

PHOTOMETRIC SPECIFICATIONS

ISOCANDELA PLOT

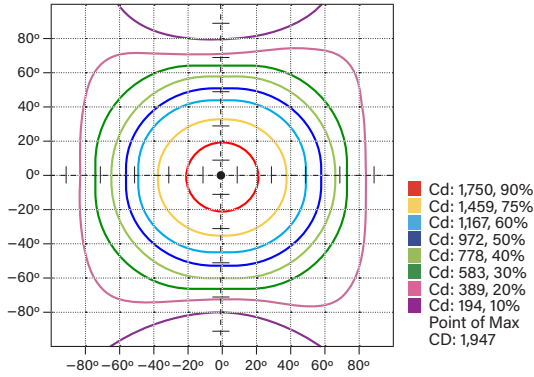

POLAR CANDELA DISTRIBUTION

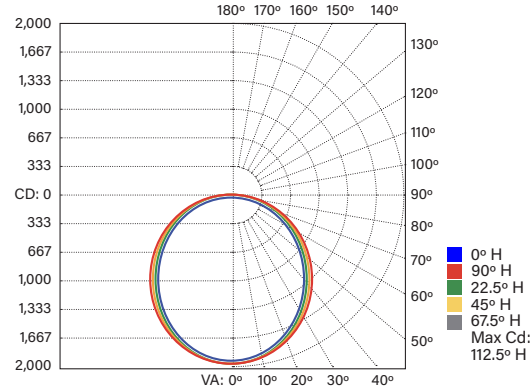

ZONAL LUMEN SUMMARY

Zone	Lumens	% Luminaire
0-30	1,471.7	24.9%
0-40	2,389.2	40.4%
0-60	4,185.5	70.8%
60-90	1,430.6	24.2%
70-100	889.3	15.0%
90-120	258.3	4.4%
0-90	5,616.0	95.0%
90-180	293.3	5.0%
0-180	5,909.3	100%

PHYSICAL SPECIFICATIONS

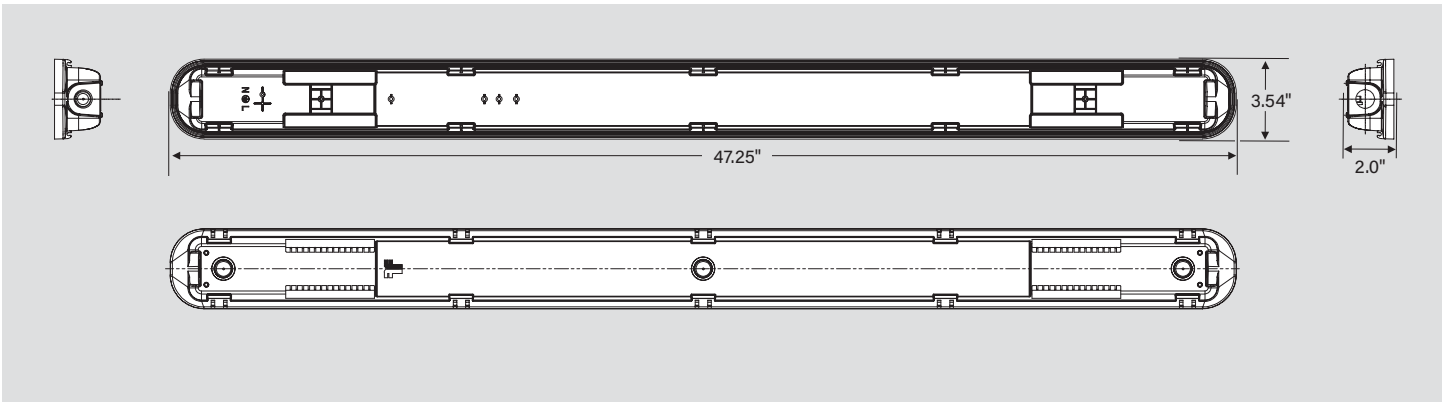

WIRING DIAGRAMS

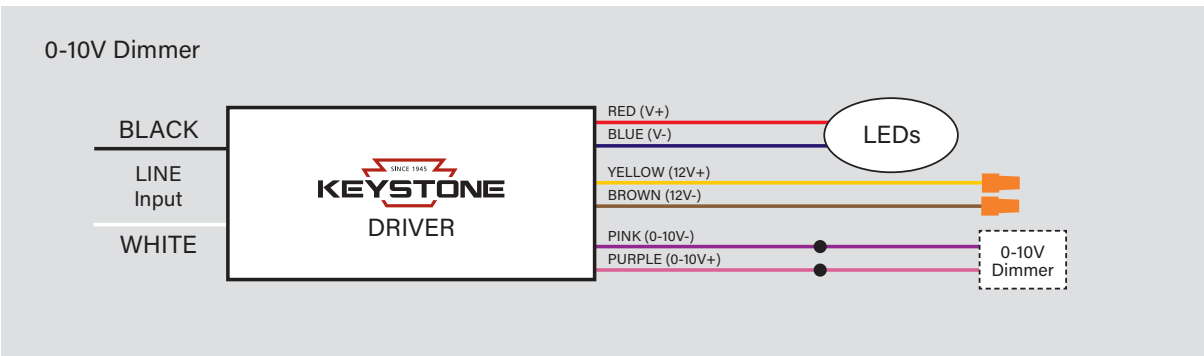

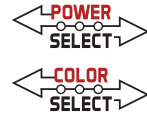

KT-VTLED44PS-4A-8CSA-VDIM

LED VAPORTIGHT FIXTURE

ACCESSORIES

SENSORS

Factory-Installable OR Field-Installable (field-installable purchased separately)

✓	SUFFIX*	CATALOG NUMBER	DESCRIPTION	UPC	EASY CODE
	/MW3	KTS-MW3-UV-KO-K2	Microwave Multifunction Occupancy/Daylight Sensor Kit, Includes 120-277V input to 12V DC convertor, IP65 12V input sensor head, nomex sleeve, extension neck	843654134352	TBV-76



* FOR FACTORY INSTALLATION OF ACCESSORY, ADD SUFFIX TO FIXTURE PART NUMBER (SEE ORDERING EXAMPLES AND INSTRUCTIONS ON LAST PAGE OF SPEC SHEET).

CORD SETS

Factory-Installable OR Field-Installable (field-installable purchased separately)

✓	SUFFIX*	CATALOG NUMBER	DESCRIPTION	UPC	EASY CODE
	/515P6	KT-CS-515P-6-18/3	Cord set for high bay; 125V NEMA 5-15P; straight blade plug; 6' SJTOW cable; 18/3 wire	843654140124	UKH-26
	/L715P10	KT-CS-L715P-10-16/3	Cord set for high bays; 277V NEMA L7-15P; twist lock plug; 10' SJTOW cable; 16/3 wire	843654140131	SFV-88
	/L615P10	KT-CS-L615P-10-16/3	Cord set for high bays; 250V NEMA L6-15P; twist lock plug; 10' SJTOW cable; 16/3 wire	843654140148	ZQS-05
	/L515P10	KT-CS-L515P-10-16/3	Cord set for high bays; 125V NEMA L5-15P; twist lock plug; 10' SJTOW cable; 16/3 wire	843654140155	GVH-22
	/L715P6	KT-CS-L715P-6-16/3	Cord set for high bays; 277V NEMA L7-15P; twist lock plug; 6' SJTOW cable; 16/3 wire	843654140162	DVU-44
	/L615P6	KT-CS-L615P-6-16/3	Cord set for high bays; 250V NEMA L6-15P; twist lock plug; 6' SJTOW cable; 16/3 wire	843654140179	LCW-66
	/L515P6	KT-CS-L515P-6-16/3	Cord set for high bays; 125V NEMA L5-15P; twist lock plug; 6' SJTOW cable; 16/3 wire	843654140186	POC-82
	/NP10	KT-CS-NP-10-16/3	Cord for high bays; no plug; inners 1/2" strip on both ends; 10' SJTOW cable; 16/3 wire	843654140193	YOH-90
	/NP6	KT-CS-NP-6-16/3	Cord for high bays; no plug; inners 1/2" strip on both ends; 6' SJTOW cable; 16/3 wire	843654140216	HUB-73
	/NP15	KT-CS-NP-15-16/3	Cord for high bays; no plug; inners 1/2" strip on both ends; 15' SJTOW cable; 16/3 wire	843654140209	EYD-18

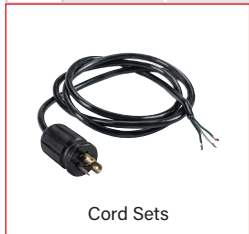

* FOR FACTORY INSTALLATION OF ACCESSORY, ADD SUFFIX TO FIXTURE PART NUMBER (SEE ORDERING EXAMPLES AND INSTRUCTIONS ON LAST PAGE OF SPEC SHEET).
NOTE: FOR CORD SETS NOT LISTED HERE, PLEASE CONTACT YOUR KEYSTONE SALES REP.

(Accessories continued on next page)

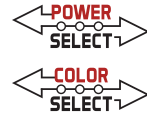

KT-VTLED44PS-4A-8CSA-VDIM

LED VAPORTIGHT FIXTURE

ACCESSORIES (continued)

EMERGENCY BACKUP

Factory-Installable OR Field-Installable (field-installable purchased separately)

✓	SUFFIX*	CATALOG NUMBER	DESCRIPTION	UPC	EASY CODE
	/EM5	KT-EMRG-LED-5C-500	5W, 500 lumen Smart Safe emergency backup	843654103099	JTR-48
	/EM12	KT-EMRG-LED-12C-1200	12W, 1200 lumen Smart Safe emergency backup	843654103112	OJQ-32

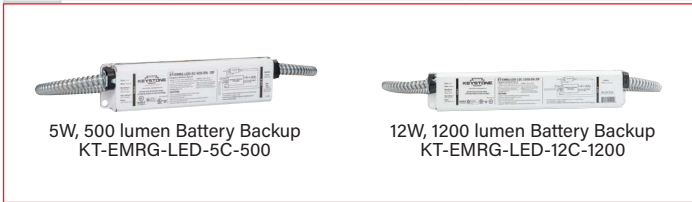

* FOR FACTORY INSTALLATION OF ACCESSORY, ADD SUFFIX TO FIXTURE PART NUMBER (SEE ORDERING EXAMPLES AND INSTRUCTIONS ON LAST PAGE OF SPEC SHEET).
 † FACTORY INSTALLATION OF EMERGENCY BACKUP UNITS WILL AUTOMATICALLY INCLUDE ANY RELEVANT MOUNTING BRACKET.

MOUNTS AND BRACKETS

Field-Installable / Field-Use ONLY (purchased separately)

CATALOG NUMBER	DESCRIPTION	UPC	EASY CODE
KT-VTLED-45SM-1-KIT	45° steel surface mount kit for all Keystone vapor tight fixtures	843654123455	JDN-49
KT-VTLED-TPSCREW-KIT	Screws for tamper-proofing vapor tight fixtures. Includes 14 screws	TBD	TBD



(Accessories continued on next page)

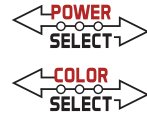

KT-VTLED44PS-4A-8CSA-VDIM

LED VAPORTIGHT FIXTURE

ORDERING INFORMATION

ORDER CODE	PACK QUANTITY	UPC	EASY CODE	DLC PRODUCT ID
KT-VTLED44PS-4A-8CSA-VDIM	1	843654134451	TFZ-02	PEMNI17A
				S-QHSKVR
				PD01Q4XH

CATALOG NUMBER BREAKDOWN

KT-VTLED44PS-4A-8CSA-VDIM

1	2	3	4	5	6	7	8	9	10	11	
1 Keystone Technologies	2 LED Vaportight Fixture	3 Wattage	4 Power Select	5 4' Nominal Length	6 Lmap Type	7 80 CRI	8 Color Temperature	9 Color Select Designation	10 0-10V Dimming	11 Additional Options	
								9 Color Select Designation			
								A	3500K, 4000K, 5000K		
										/MW3	Microwave Occupancy Sensor Installed
										No Option	

ORDERING EXAMPLES

FIXTURE WITH MULTIPLE FACTORY-INSTALLED ACCESSORIES*

KT-VTLED44PS-4A-8CSA-VDIM/MW3/NP10/EM5

FIXTURE WITH MULTIPLE FACTORY-INSTALLED ACCESSORIES*

KT-VTLED44PS-4A-8CSA-VDIM/MW3/EM5

FIXTURE WITH TWO FACTORY-INSTALLED ACCESSORIES*

KT-VTLED44PS-4A-8CSA-VDIM/MW3NP10

FIXTURE WITH SINGLE FACTORY-INSTALLED ACCESSORY

KT-VTLED44PS-4A-8CSA-VDIM/MW3

FIXTURE WITH NO FACTORY-INSTALLED ACCESSORIES

KT-VTLED44PS-4A-8CSA-VDIM

KEYSTONE FIXTURE	
CATALOG NUMBER	
KT-VTLED44PS-4A-8CSA-VDIM	

SENSORS	
SUFFIX	CATALOG NUMBER
✓ /MW3	KTS-MW3-UV-KO-K2

CORD SETS	
SUFFIX	CATALOG NUMBER
✓ /NP10	KT-CS-NP-10-16/3

EMERGENCY BACKUP	
SUFFIX	CATALOG NUMBER
✓ /EM5	KT-EMRG-LED-5C-500

* WHEN ORDERING MORE THAN ONE FACTORY-INSTALLED ACCESSORY, USE MULTIPLE SUFFIXES AS SHOWN IN THE ORDERING EXAMPLES ABOVE.
NOTE: ALL ACCESSORIES CAN ALSO BE ORDERED SEPARATELY FOR FIELD INSTALLATION USING JUST THEIR REGULAR CATALOG NUMBER, UPC, OR EASY CODE.