

# KT-LED63PSHID-H-EX39-8CSB-D

## HORIZONTAL HID POWER AND COLOR SELECT LED LAMP

### DESCRIPTION

63W HID Replacement LED Lamp Designed for Horizontal Applications  
 Power Select | Color Select | 80 CRI | IP64



<b>LAMP TYPE:</b> Horizontal HID LED Lamp
<b>BASE TYPE:</b> EX39 (Mogul) Rotatable
<b>WATTAGE:</b> 63/54/45W
<b>COLOR TEMPERATURE:</b> 3000/4000/5000K
<b>METAL HALIDE EQUIVALENT:</b> 250W
<b>COLOR RENDERING INDEX (CRI):</b> >80
<b>WARRANTY:</b> 5 Years

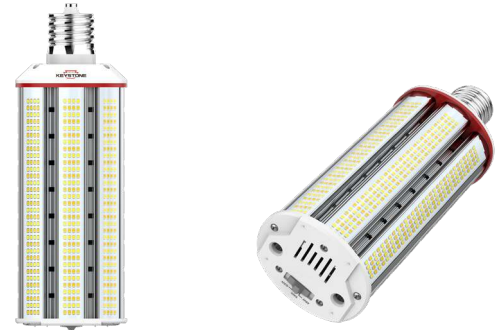

### PRODUCT FEATURES

- Replacement for conventional metal halide lamp
- Optimized for horizontal applications, ideal for wall pack retrofits
- Environmentally friendly: No mercury used
- Instant startup
- Integral driver eliminates the need for external driver or legacy ballast; includes 4kV surge protection
- Step dimmable with Power Select Switch. See below image.
- 50,000+ hour lifetime
- Operating temperature: 30°C/-22°F - 45°C/113°F
- Suitable for use in enclosed fixtures
- Minimum lamp compartment dimensions: 8" x 8" x 8.7"
- UL listed
- IP64 rated; integrated heat sink quickly dissipates heat and guides water intrusion out of the lamp

### PERFORMANCE SPECIFICATIONS

Catalog Number	Input Voltage	Selectable Power	Selectable CCT	Lumens	Efficacy	Input Voltage	Base	DLC	CRI	Metal Halide Equivalent
KT-LED63PSHID-H-EX39-8CSB-D	120-277V	63W	3000K	8945	142 lm/W	120-277V	EX39	Yes	>80	250W MH
			4000K	9575	152 lm/W					
			5000K	9135	145 lm/W					
		54W	3000K	7720	143 lm/W					
			4000K	8045	149 lm/W					
			5000K	7830	145 lm/W					
		45W	3000K	6750	150 lm/W					
			4000K	7020	156 lm/W					
			5000K	6840	152 lm/W					

### SELECTABILITY

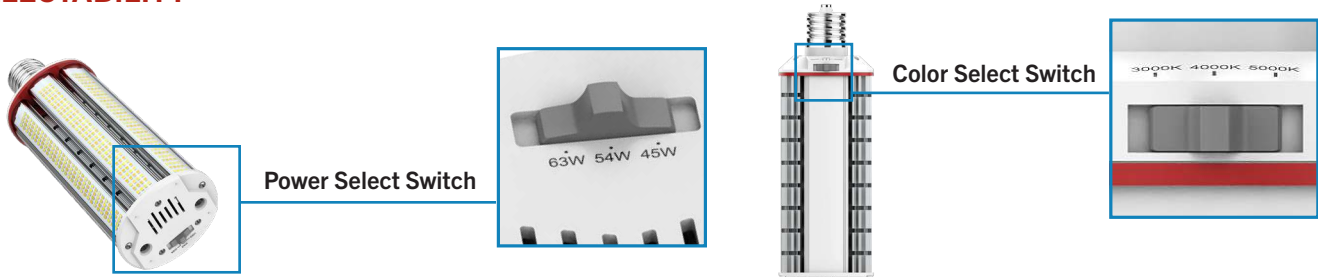

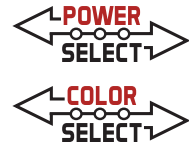

# KT-LED63PSHID-H-EX39-8CSB-D

## HORIZONTAL HID POWER AND COLOR SELECT LED LAMP

### PHYSICAL CHARACTERISTICS

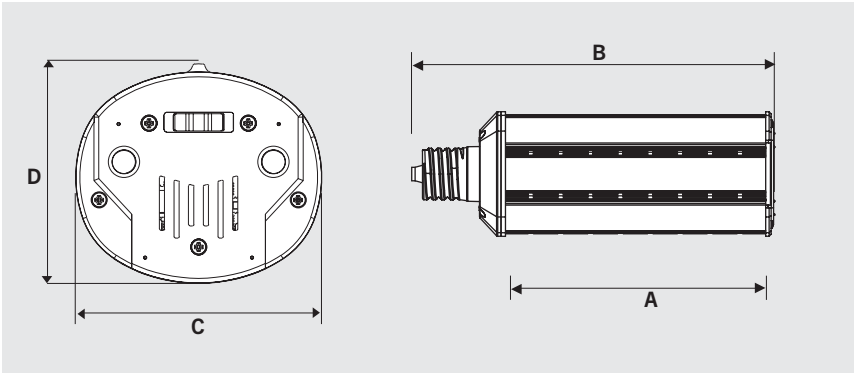

### LAMP DIMENSIONS

A (Illuminated Length)	7.56"
B (Body Length)	10.67"
C (Width)	3.62"
D Diameter	3.23"

**BASE TYPE:** EX39 (Mogul) Rotatable

### WIRING INSTRUCTIONS

#### STEP 1

**Disconnect power.** Disconnect and remove existing ballast, capacitor, and/or ignitor (where applicable) from fixture.

#### STEP 2

Rewire for line voltage to the lamp socket. Lamp is compatible with 120-277V from single phase, three phase wye, and three phase delta systems.

#### STEP 3

Install new LED replacement lamp. Ensure lamp is operating properly when power is turned on.

#### STEP 1

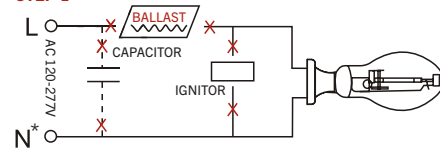

#### STEP 2



#### STEP 3

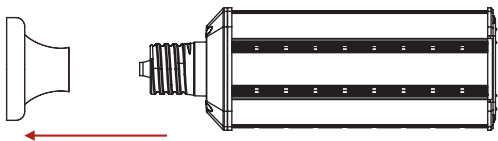
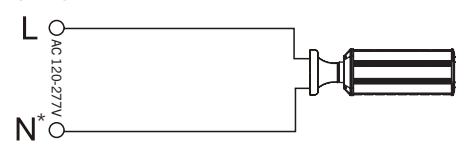

\*or other line for certain three phase systems such as 120/208 three phase wye systems

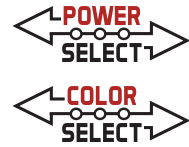

# KT-LED63PSHID-H-EX39-8CSB-D

## HORIZONTAL HID POWER AND COLOR SELECT LED LAMP

**ORDERING INFORMATION**

ORDER CODE	PACK QTY.	EASY CODE	UPC
KT-LED63PSHID-H-EX39-8CSB-D	12	EZE-77	843654138916

**CATALOG NUMBER BREAKDOWN**

# KT-LED63PSHID-H-EX39-8CSB-D

1
2
3
4
5
6
7
8
9
10
11

- 1** Keystone Technologies
- 2** LED Lamp
- 3** Max Wattage
- 4** Power Select
- 5** Lamp Type
- 6** Orientation
- 7** Base Type
- 8** 80 CRI
- 9** Color Select
- 10** Color Select Designation
- 11** Direct Drive

**10 Color Select Designation**

B	3000/4000/5000K
---	-----------------