

HB-LED-2B-215PS-8CSD-P

2' LED HIGH BAY



Compact 215W LED High Bay Fixture; 120–277V Input, 0–10V Dimming

DESCRIPTION

2' LED High Bay Fixture | 120–277V Input | Frosted Lens | 0–10V Dimming | Premium Series

APPLICATION

Used for commercial and industrial high bay lighting applications

PRODUCT FEATURES

- Architectural grade compact design
- Includes screw-in receptacle for easy sensor and control installation
- Compatible with emergency LED drivers; mounting kit required (sold separately)
- Powered by 0-10V dim-to-off driver with 12VDC, 200mA AUX output
- Frosted lens eliminates glare
- Smooth diffused lens for an even appearance
- Compatible with 480–277V step down transformers
- Built in port to accept Quick install sensor, NO wiring required
- V-hook and chain mounting accessories included
- UL Certified for Dry and Damp Locations
- Ambient operating temperature: –40°C/–4°F to 50°C/122°F
- THD: < 20%
- PF: > 0.95
- LED chip lifetime: L70 >50,000 hrs @ 25°C/77°F ambient fixture temp.



10 YEAR
LIMITED WARRANTY

POWER AND COLOR TEMPERATURE SELECTABILITY

- CCT Selectable Technology: Adjustable CCT (4000K/5000K)
- Wattage Selectable Technology: Adjustable Wattage (215W/175W/135W)



PRODUCT SPECIFICATIONS

Catalog Number	Input Voltage	Wattage	CCT	Lumen Output	Efficacy	CRI	Power Factor	Lifetime
HB-LED-2B-215PS-8CSD-P	120–277V	215W	4000K	30,600	142 lm/W	> 80	> 0.90	50,000 hrs
			5000K					
		175W	4000K	26,000	149 lm/W			
			5000K					
		135W	4000K	20,900	155 lm/W			
			5000K					

* Preset to highest lumen output (215W / 5000K)

* Color Uniformity: CCT (Correlated Color Temperature) range as per guidelines outlined in ANSI C78.377-2017.

HB-LED-2B-215PS-8CSD-P

2' LED HIGHBAY

PHOTOMETRIC SPECIFICATIONS

ISOCANDELA PLOT

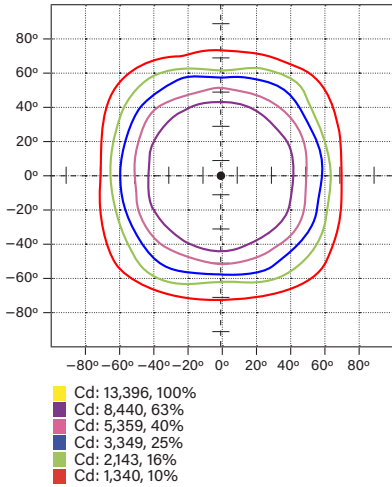

AVERAGE ILLUMINANCE

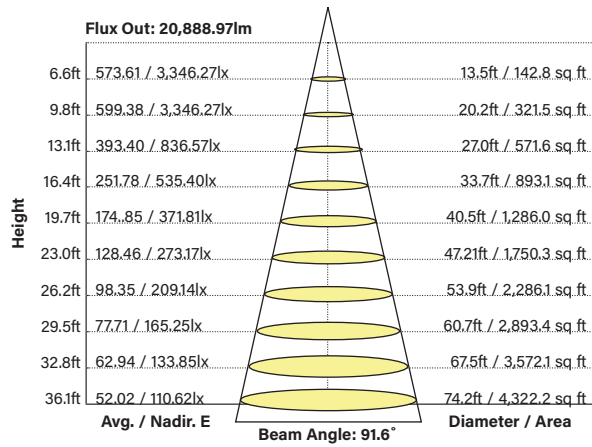

ZONAL LUMEN SUMMARY

Zone	Lumens	% Luminaire
0-60	27,071	88%
60-90	3,353	11%
0-90	30,424	100%

PHYSICAL SPECIFICATIONS

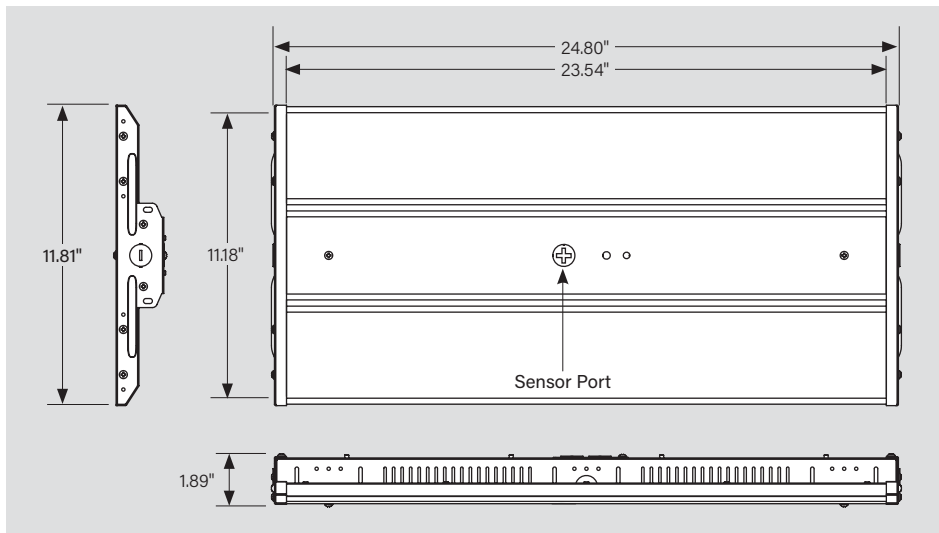

Weight	12.6 lb
---------------	---------

HB-LED-2B-215PS-8CSD-P

2' LED HIGH BAY

ACCESSORIES

SENSORS AND CONTROLLERS

Factory-Installable OR Field-Installable (field-installable purchased separately)

✓	SUFFIX*	CATALOG NUMBER	DESCRIPTION	UPC	EASY CODE
	/FC3	KTSL-FC3-12V-PKO-PIR	Smart Loop Bluetooth mesh screw-in PIR occupancy sensor with built-in fixture controller. No wiring required.	843654138862	OCW-60
	/FC4	KTSL-FC4-12V-PKO	Smart Loop Bluetooth mesh screw-in low voltage fixture controller, 12V, 0-10V Dimming	843654149066	RUN-10
	/PIR2	KTS-PIR2-UV-KO	PIR sensor for high bay fixtures; Preset for 5 min hold time, 10 min standby time at 10% dim, daylight disabled	843654123288	IOF-04
	/PIR-A	KTS-PIR3-12V-PKO /A	Smart Port PIR sensor for high bay fixtures; Preset for 1 min hold time, 3 min standby time at 30% dim, daylight disabled	843654133638	RXQ-30
	/PIR-B	KTS-PIR3-12V-PKO /B	Smart Port PIR sensor for high bay fixtures; Preset for 5 min hold time, 10 min standby time at 10% dim, daylight disabled	843654133645	LEF-34
	/MW3-A	KTS-MW3-12V PKO /A	Smart Port Microwave Occupancy sensor for high bay fixtures; Preset for 1 min hold time, 3 min standby time at 30% dim, daylight disabled	843654133317	XYR-25
	/MW3-B	KTS-MW3-12V PKO /B	Smart Port Microwave Occupancy sensor for high bay fixtures; Preset for 5 min hold time, 10 min standby time at 10% dim, daylight disabled	843654133324	SPF-37



* For factory installation of accessory, add suffix to fixture part number (see ordering examples and instructions on last page of spec sheet).

Field-Installable / Field-Use ONLY (purchased separately)

CATALOG NUMBER	DESCRIPTION	UPC	EASY CODE
KTS-MW3-REMOTECONTROL	Remote control for KTS-MW3-12V-PKO /A or /B and KTS-PIR3-12V-PKO /A or /B sensors. Used to set and adjust all sensor settings, including high-end trim brightness, sensitivity, hold time, daylight threshold, stand-by time, and stand-by dimming level.	843654132020	XSR-61

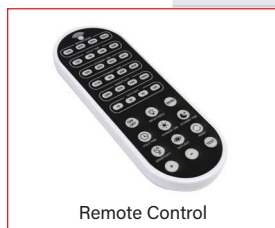

(Accessories continued on next page)

HB-LED-2B-215PS-8CSD-P

2' LED HIGH BAY

ACCESSORIES (continued)

CORD SETS

Factory-Installable OR Field-Installable (field-installable purchased separately)

✓	SUFFIX*	CATALOG NUMBER	DESCRIPTION	UPC	EASY CODE
	/515P6	KT-CS-515P-6-18/3	Cord set for high bay; 125V NEMA 5-15P; straight blade plug; 6' SJTOW cable; 18/3 wire	843654140124	UKH-26
	/L715P10	KT-CS-L715P-10-16/3	Cord set for high bays; 277V NEMA L7-15P; twist lock plug; 10' SJTOW cable; 16/3 wire	843654140131	SFV-88
	/L615P10	KT-CS-L615P-10-16/3	Cord set for high bays; 250V NEMA L6-15P; twist lock plug; 10' SJTOW cable; 16/3 wire	843654140148	ZQS-05
	/L515P10	KT-CS-L515P-10-16/3	Cord set for high bays; 125V NEMA L5-15P; twist lock plug; 10' SJTOW cable; 16/3 wire	843654140155	GVH-22
	/L715P6	KT-CS-L715P-6-16/3	Cord set for high bays; 277V NEMA L7-15P; twist lock plug; 6' SJTOW cable; 16/3 wire	843654140162	DVU-44
	/L615P6	KT-CS-L615P-6-16/3	Cord set for high bays; 250V NEMA L6-15P; twist lock plug; 6' SJTOW cable; 16/3 wire	843654140179	LCW-66
	/L515P6	KT-CS-L515P-6-16/3	Cord set for high bays; 125V NEMA L5-15P; twist lock plug; 6' SJTOW cable; 16/3 wire	843654140186	POC-82
	/MC63	KT-MC-NP-6-18/3	MC cable whip for high bays; no plug; inners 1/2" strip on both ends; 6' metal-clad cable; 18/3 wire	843654134505	EYP-82
	/MC65	KT-MC-NP-6-18/5	MC cable whip for high bays; no plug; inners 1/2" strip on both ends; 6' metal-clad cable; 18/5 wire (dimming wires included)	843654134512	CBU-56
	/NP10	KT-CS-NP-10-16/3	Cord for high bays; no plug; inners 1/2" strip on both ends; 10' SJTOW cable; 16/3 wire	843654140193	YOH-90
	/NP6	KT-CS-NP-6-16/3	Cord for high bays; no plug; inners 1/2" strip on both ends; 6' SJTOW cable; 16/3 wire	843654140216	HUB-73
	/NP15	KT-CS-NP-15-16/3	Cord for high bays; no plug; inners 1/2" strip on both ends; 15' SJTOW cable; 16/3 wire	843654140209	EYD-18
	/NP6D	KT-CS-NP-6-18/5	Cord for fixtures; no plug; inners 1/2" strip on both ends; 6' long black SJTOW cable; 300V; 18/5 wire	843654153346	ANT-58
	/NP6D	KT-CS-NP-6-18/6	Cord for fixtures; no plug; inners 1/2" strip on both ends; 6' long black SJTOW cable; 300V; 18/6 wire. For use with Emergency	843654153353	ZRX-06
	/NP10D	KT-CS-NP-10-18/5	Cord for fixtures; no plug; inners 1/2" strip on both ends; 10" long black SJTOW cord; 300V; 18/5 wire	843654153360	DSZ-45
	/NP10D	KT-CS-NP-10-18/6	Cord for fixtures; no plug; inners 1/2" strip on both ends; 10" long black SJTOW cord; 300V; 18/6 wire. For use with Emergency	843654153377	FFI-18
	/NP15D	KT-CS-NP-15-18/5	Cord for fixtures; no plug; inners 1/2" strip on both ends; 15" long black SJTOW cord; 300V; 18/5 wire	843654153384	JEB-96
	/NP15D	KT-CS-NP-15-18/6	Cord for fixtures; no plug; inners 1/2" strip on both ends; 15" long black SJTOW cord; 300V; 18/6 wire. For use with Emergency	843654153391	RQV-39
	/NP20D	KT-CS-NP-20-18/5	Cord for fixtures; no plug; inners 1/2" strip on both ends; 20" long black SJTOW cord; 300V; 18/5 wire	843654154442	USN-91
	/NP20D	KT-CS-NP-20-18/6	Cord for fixtures; no plug; inners 1/2" strip on both ends; 20" long black SJTOW cord; 300V; 18/6 wire. For use with Emergency	843654154459	JCN-20
	/NP22D	KT-CS-NP-22-18/5	Cord for fixtures; no plug; inners 1/2" strip on both ends; 20" long black SJTOW cord; 300V; 18/5 wire	843654153407	DUH-47
	/NP22D	KT-CS-NP-22-18/6	Cord for fixtures; no plug; inners 1/2" strip on both ends; 20" long black SJTOW cord; 300V; 18/6 wire. For use with Emergency	843654153414	ITP-55



Cord Sets

* For factory installation of accessory, add suffix to fixture part number (see ordering examples and instructions on last page of spec sheet).
Note: For cord sets not listed here, please contact your Keystone sales rep.

(Accessories continued on next page)

HB-LED-2B-215PS-8CSD-P

2' LED HIGH BAY

ACCESSORIES (continued)

EMERGENCY BACKUP

Factory-Installable OR Field-Installable (field-installable purchased separately)

✓	SUFFIX*	CATALOG NUMBER	DESCRIPTION	UPC	EASY CODE
	/EM5†	KT-EMRG-LED-5C-500-EN /DF	5W, 500 lumen Smart Safe emergency backup with dual flex cables	843654132433	RAR-74
	/EM12†	KT-EMRG-LED-12C-1200-EN /DF	12W, 1200 lumen Smart Safe emergency backup with dual flex cables	890949019900	YCV-23
	/EM20†	KT-EMRG-LED-20SD-2000-EN /DF	20W, 2000 lumen Smart Safe emergency backup with dual flex cables; Self-diagnostic	843654103143	BZU-19



5W, 500 lumen Battery Backup
KT-EMRG-LED-5C-500-EN /DF



12W, 1200 lumen Battery Backup
KT-EMRG-LED-12C-1200-EN /DF



20W, 2000 lumen Battery Backup
KT-EMRG-LED-20SD-2000-EN /DF



* For factory installation of accessory, add suffix to fixture part number (see ordering examples and instructions on last page of spec sheet).
† Factory installation of emergency backup units will automatically include any relevant mounting bracket.

Field-Installable / Field-Use ONLY (purchased separately)

CATALOG NUMBER	DESCRIPTION	UPC	EASY CODE
KT-HBLED-EM-BR-1B-KIT	Emergency LED backup mounting bracket kit for LED high bay fixtures	843654133737	LAJ-08



Emergency Backup Mounting Bracket
KT-HBLED-EM-BR-1B-KIT



MOUNTS AND BRACKETS

Factory-Installable OR Field-Installable (field-installable purchased separately)

✓	SUFFIX*	CATALOG NUMBER	DESCRIPTION	UPC	EASY CODE
	/WG	KT-HBLED-WG-1B-KIT	Wire guard kit for 2FB Linear LED high bay fixtures	843654134765	GSX-74

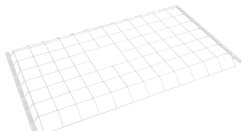

Wire Guard Kit
KT-HBLED-WG-1B-KIT



* For factory installation of accessory, add suffix to fixture part number (see ordering examples and instructions on last page of spec sheet).

(Accessories continued on next page)

HB-LED-2B-215PS-8CSD-P

2' LED HIGH BAY

ACCESSORIES (continued)

Field-Installable / Field-Use ONLY (purchased separately)



CATALOG NUMBER	DESCRIPTION	UPC	EASY CODE
KT-HBLED-PM-1B-KIT	Pendant mount kit for LED high bay fixtures	843654133706	XAA-31
KT-HBLED-SM-1B-KIT	Surface mount kit for LED high bay fixtures	843654133690	LGJ-33
KT-HBLED-CABLE-1B-KIT	Aircraft cable hanging kit for LED high bay fixtures	843654133720	WMG-60

 <p>Pendant Mount Kit KT-HBLED-PM-1B-KIT</p>		 <p>Surface Mount Kit KT-HBLED-SM-1B-KIT</p>	
 <p>Cable Mount Kit KT-HBLED-CABLE-1B-KIT</p>			

STEP-DOWN TRANSFORMERS

Factory-Installable OR Field-Installable (field-installable purchased separately)

✓	SUFFIX*	CATALOG NUMBER	DESCRIPTION	UPC	EASY CODE
	/480†	KTAT-250-480-277 /SF	Fully enclosed, single flex step-down transformer for LED high bay fixtures (250VA or lower)	843654102931	XIM-17

 <p>Step-Down Transformer KTAT-250-480-277 /SF</p>	
---	---

* For factory installation of accessory, add suffix to fixture part number (see ordering examples and instructions on last page of spec sheet).

† Factory installation of step-down transformer units will automatically include any relevant mounting bracket.

* Step-down transformers cannot be ordered in conjunction with standard SJTOW cord set options (contact Keystone sales rep for available custom options if needed).

HB-LED-2B-215PS-8CSD-P

2' LED HIGH BAY

ORDERING INFORMATION

Catalog Number	Pack Quantity	UPC	Easy Code
HB-LED-2B-215PS-8CSD-P	1	843654134390	JIF-88

FIXTURE CATALOG NUMBER BREAKDOWN

HB-LED-2B-215PS-8CSD-P

1	2	3	4	5	6	7	8	9	10
---	---	---	---	---	---	---	---	---	----

- 1 High Bay Fixture
- 2 LED
- 3 Nominal Length
- 4 Shape
- 5 Wattage
- 6 Wattage Selectable
- 7 80 CRI
- 8 CCT Selectable
- 9 CCT Designation
- 10 Premium Series

ORDERING EXAMPLES

FIXTURE WITH MULTIPLE FACTORY-INSTALLED ACCESSORIES*

HB-LED-2B-215PS-8CSD-P/PIR2/L715P6/EM5/WG-4



FIXTURE WITH MULTIPLE FACTORY-INSTALLED ACCESSORIES*

HB-LED-2B-215PS-8CSD-P/PIR2/EM5/WG-4/480

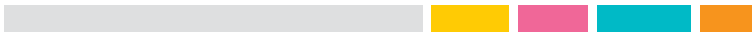

FIXTURE WITH TWO FACTORY-INSTALLED ACCESSORIES*

HB-LED-2B-215PS-8CSD-P/PIR2/480



FIXTURE WITH SINGLE FACTORY-INSTALLED ACCESSORY

HB-LED-2B-215PS-8CSD-P/PIR2

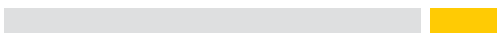

FIXTURE WITH NO FACTORY-INSTALLED ACCESSORIES

HB-LED-2B-215PS-8CSD-P

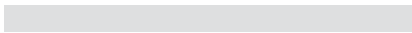

* When ordering more than one factory-installed accessory, use multiple suffixes as shown in the ordering examples above.
Note: All accessories can also be ordered separately for field installation using just their regular Catalog Number, UPC, or Easy Code.

KEYSTONE FIXTURE

CATALOG NUMBER
HB-LED-2B-215PS-8CSD-P

SENSORS AND CONTROLLERS

SUFFIX	CATALOG NUMBER
✓ /PIR2	KTS-PIR2-UV-KO

CORD SETS

SUFFIX	CATALOG NUMBER
✓ /L715P6	KT-CS-L715P-6-16/3

EMERGENCY BACKUP

SUFFIX	CATALOG NUMBER
✓ /EM5	KT-EMRG-LED-5C-500-EN /DF

MOUNTS AND BRACKETS

SUFFIX	CATALOG NUMBER
✓ /WG-4	KT-HBLED-WG-4-KIT /G2

STEP-DOWN TRANSFORMERS

SUFFIX	CATALOG NUMBER
✓ /480	KTAT-250-480-277 /SF

Note: Step-down transformers cannot be ordered in conjunction with standard SJTOW cord set options (contact Keystone sales rep for available custom options if needed).