

KT-BPLED40PS-22-8CSA-VDIM /G2

BACKLIT LED PANEL LIGHT

DESCRIPTION

2'x2' LED panel light, 20, 30 and 40W, 120-277V input, 0-10V dimming Generation 2



PRODUCT FEATURES

- Aluminum frame featuring stepped edge design detail and gloss white paint for improved aesthetics
- New backlit style design; fits standard T-grid ceilings
- Suitable for recessed or surface mount (with optional accessories)*
- Construction features precise optical lenses over each individual LED, offering optimal light diffusion and consistent surface illumination, with no risk of yellowing over product lifetime
- Suitable for damp locations
- Powered by Keystone 0-10V dimmable LED driver with built-in junction box
- Compatible with Keystone SmartSafe LED emergency backup
- Over 50% energy savings compared to traditional fluorescent troffers
- Operating temp range -20°C/-4°F to 40°C/104°F

* For use in non-fire rated installations only

PERFORMANCE SPECIFICATIONS

Catalog Number	Input Voltage	Wattage	CCT	Lumen Output	Efficacy	CRI	Power Factor	Lifetime
KT-BPLED40PS-22-8CSA-VDIM /G2*	120-277V	40W	3500K	4,400	110 lm/W	>80	>0.9	50,000 Hours
			4000K	4,500	113 lm/W			
			5000K	4,450	111 lm/W			
		30W	3500K	3,400	111 lm/W			
			4000K	3,500	117 lm/W			
			5000K	3,450	115 lm/W			
		20W	3500K	2,400	111 lm/W			
			4000K	2,500	125 lm/W			
			5000K	2,450	123 lm/W			

ONE CATALOG NUMBER WITH 9 DIFFERENT OPTIONS

* Preset to highest lumen output (40W / 5000K)
 * Color Uniformity: CCT (Correlated Color Temperature) range as per guidelines outlined in ANSI C78.377-2017.

PHOTOMETRIC SPECIFICATIONS

ISOCANDELA PLOT

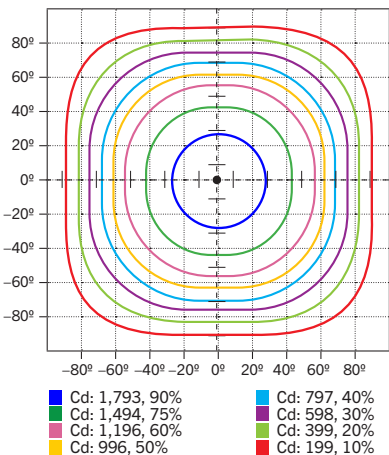

POLAR CANDELA DISTRIBUTION

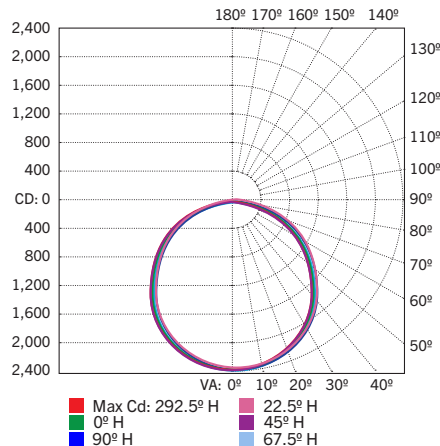

ZONAL LUMEN SUMMARY

Zone	Lumens	% Luminaire
0-60	3,252.2	78.4%
60-90	891.5	21.5%
0-90	4,143.7	99.9%
90-180	3.9	0.1%
0-180	4,147.6	100%

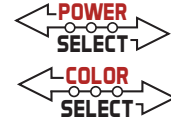

KT-BPLED40PS-22-8CSA-VDIM /G2

BACKLIT LED PANEL LIGHT

PHYSICAL SPECIFICATIONS

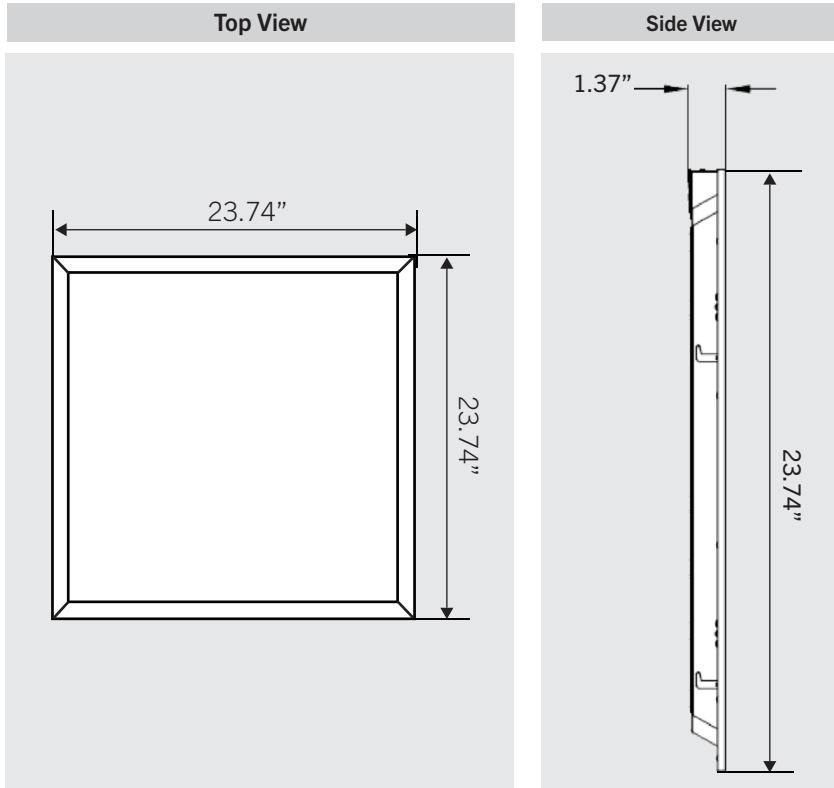

WEIGHT INFORMATION

1 Piece	1 Carton
6.2 lbs	12.4 lbs

EXPLODED VIEW

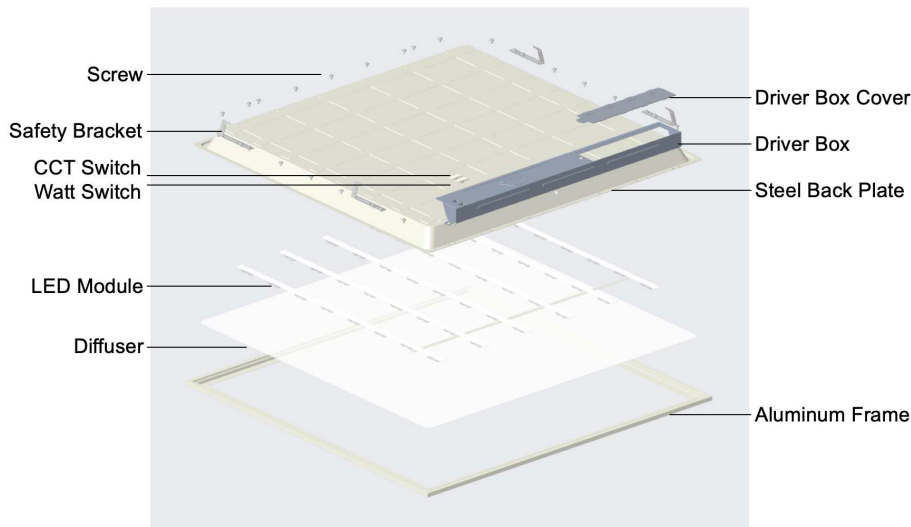

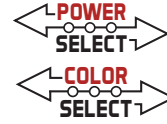

KT-BPLED40PS-22-8CSA-VDIM /G2

BACKLIT LED PANEL LIGHT

ACCESSORIES (continued)

SENSORS

Factory-Installable OR Field-Installable (field-installable purchased separately)

✓	SUFFIX*	CATALOG NUMBER	DESCRIPTION	UPC	EASY CODE
	/FC1-PIR	KTSL-FC1-UV-KO-PIR	Bluetooth Mesh Wireless Fixture Controller for SmartLoop System with emote mountable daylight and PIR motion sensor. 120-277V. 3A Max Load with 0-10V Dimming	 843654129259	MGZ-59



* For factory installation of accessory, add suffix to fixture part number (see ordering examples and instructions on last page of spec sheet).

CORD SETS

Factory-Installable OR Field-Installable (field-installable purchased separately)

✓	SUFFIX*	CATALOG NUMBER	DESCRIPTION	UPC	EASY CODE
	/515P6	KT-CS-515P-6-18/3	Cord set for high bay; 125V NEMA 5-15P; straight blade plug; 6' SJTOW cable; 18/3 wire	843654140124	UKH-26
	/L715P10	KT-CS-L715P-10-16/3	Cord set for high bays; 277V NEMA L7-15P; twist lock plug; 10' SJTOW cable; 16/3 wire	843654140131	SFV-88
	/L615P10	KT-CS-L615P-10-16/3	Cord set for high bays; 250V NEMA L6-15P; twist lock plug; 10' SJTOW cable; 16/3 wire	843654140148	ZQS-05
	/L515P10	KT-CS-L515P-10-16/3	Cord set for high bays; 125V NEMA L5-15P; twist lock plug; 10' SJTOW cable; 16/3 wire	843654140155	GVH-22
	/L715P6	KT-CS-L715P-6-16/3	Cord set for high bays; 277V NEMA L7-15P; twist lock plug; 6' SJTOW cable; 16/3 wire	843654140162	DVU-44
	/L615P6	KT-CS-L615P-6-16/3	Cord set for high bays; 250V NEMA L6-15P; twist lock plug; 6' SJTOW cable; 16/3 wire	843654140179	LCW-66
	/L515P6	KT-CS-L515P-6-16/3	Cord set for high bays; 125V NEMA L5-15P; twist lock plug; 6' SJTOW cable; 16/3 wire	843654140186	POC-82
	/MC63	KT-MC-NP-6-18/3	MC cable whip for high bays; no plug; inners 1/2" strip on both ends; 6' metal-clad cable; 18/3 wire	843654134505	EYP-82
	/MC65	KT-MC-NP-6-18/5	MC cable whip for high bays; no plug; inners 1/2" strip on both ends; 6' metal-clad cable; 18/5 wire (dimming wires included)	843654134512	CBU-56
	/NP10	KT-CS-NP-10-16/3	Cord for high bays; no plug; inners 1/2" strip on both ends; 10' SJTOW cable; 16/3 wire	843654140193	YOH-90
	/NP6	KT-CS-NP-6-16/3	Cord for high bays; no plug; inners 1/2" strip on both ends; 6' SJTOW cable; 16/3 wire	843654140216	HUB-73
	/NP15	KT-CS-NP-15-16/3	Cord for high bays; no plug; inners 1/2" strip on both ends; 15' SJTOW cable; 16/3 wire	843654140209	EYD-18



* For factory installation of accessory, add suffix to fixture part number (see ordering examples and instructions on last page of spec sheet).
Note: For cord sets not listed here, please contact your Keystone sales rep.

(Accessories continued on next page)

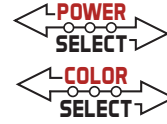

KT-BPLED40PS-22-8CSA-VDIM /G2

BACKLIT LED PANEL LIGHT

ACCESSORIES (continued)

EMERGENCY BACKUP

Factory-Installable OR Field-Installable (field-installable purchased separately)

✓	SUFFIX*	CATALOG NUMBER	DESCRIPTION	UPC	EASY CODE
	/EM5†	KT-EMRG-LED-5C-500-EN /DF	5W, 500 lumen Smart Safe emergency backup with dual flex cables	843654132433	RAR-74
	/EM12†	KT-EMRG-LED-12C-1200-EN /DF	12W, 1200 lumen Smart Safe emergency backup with dual flex cables	890949019900	YCV-23



* For factory installation of accessory, add suffix to fixture part number (see ordering examples and instructions on last page of spec sheet).
 † Factory installation of emergency backup units will automatically include any relevant mounting bracket.

Field-Installable / Field-Use ONLY (purchased separately)

CATALOG NUMBER	DESCRIPTION	UPC	EASY CODE
KT-BPLED-EM-22/4-KIT	Emergency LED backup mounting bracket kit for LED high bay fixtures	843654128047	EIG-03

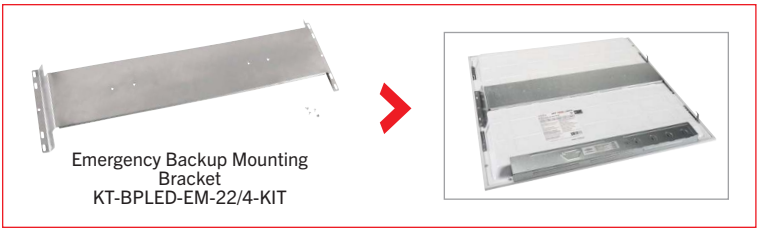

(Accessories continued on next page)

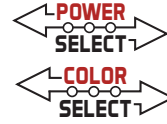

KT-BPLED40PS-22-8CSA-VDIM /G2

BACKLIT LED PANEL LIGHT

ACCESSORIES (continued)

MOUNTS AND BRACKETS

Factory-Installable OR Field-Installable (field-installable purchased separately)

✓	SUFFIX*	CATALOG NUMBER	DESCRIPTION	UPC	EASY CODE
	/JBOX	KT-BPLED-JBOX-1	Larger J-Box add-on for LED Backlit Panels	843654128092	MYW-25

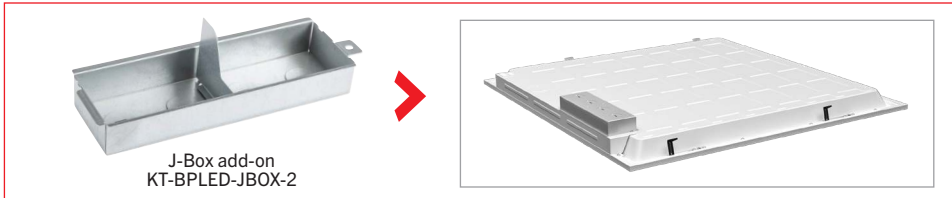

** For factory installation of accessory, add suffix to fixture part number (see ordering examples and instructions on last page of spec sheet).*

Field-Installable / Field-Use ONLY (purchased separately)

CATALOG NUMBER	DESCRIPTION	UPC	EASY CODE
KT-BPLED-SM-22-KIT /G2	Surface Mount Kit 2x2 Backlit panels	843654134543	CGY-52
KT-BPLED-CABLE-KIT	Aircraft cable hanging kit for LED high bay fixtures	843654133423	JLB-77

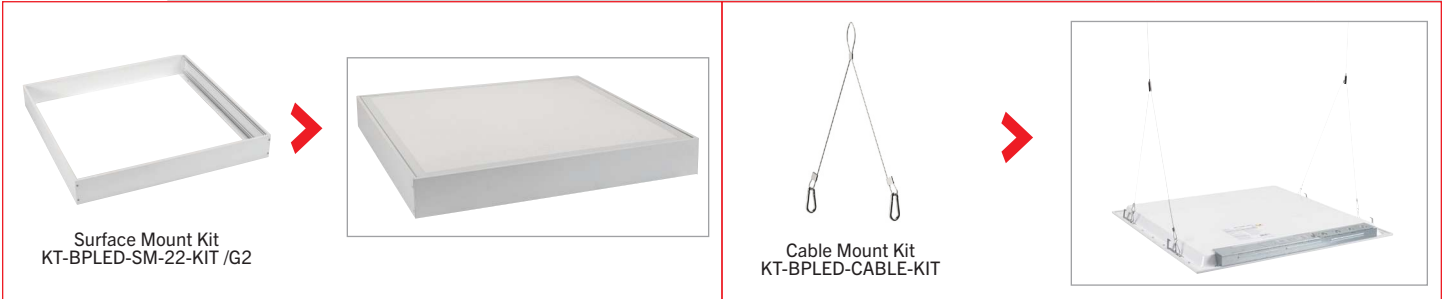

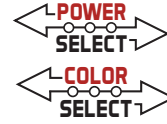

KT-BPLED40PS-22-8CSA-VDIM /G2

BACKLIT LED PANEL LIGHT

ORDERING INFORMATION

CATALOG NUMBER	CARTON QTY.	EASY CODE	UPC	DLC PRODUCT ID
KT-BPLED40PS-22-8CSA-VDIM /G2	2	OYB-58	843654127866	PKX4ZDPD

CATALOG NUMBER BREAKDOWN

KT-BPLED40PS-22-8CSA-VDIM /G2

1 2 3 4 5 6 7 8 9 10

- 1 Keystone Technologies
- 2 Backlit Panel Light LED Fixture
- 3 Wattage
- 4 Power Select
- 5 2' x 2' Nominal Size
- 6 800 Series
- 7 Color Select
- 8 3500, 4000, or 5000K Color Temperature
- 9 0-10V Dimming
- 10 Generation 2

ORDERING EXAMPLES

FIXTURE WITH MULTIPLE FACTORY-INSTALLED ACCESSORIES*

KT-BPLED40PS-22-8CSA-VDIM /G2 /FC1-PIR/L715P6/EM5/JBOX

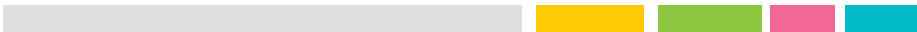

FIXTURE WITH MULTIPLE FACTORY-INSTALLED ACCESSORIES*

KT-BPLED40PS-22-8CSA-VDIM /G2 /FC1-PIR/EM5/JBOX

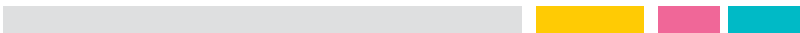

FIXTURE WITH TWO FACTORY-INSTALLED ACCESSORIES*

KT-BPLED40PS-22-8CSA-VDIM /G2 /FC1-PIR/L715P6

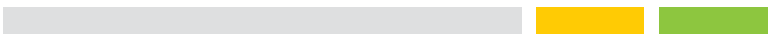

FIXTURE WITH SINGLE FACTORY-INSTALLED ACCESSORY

KT-BPLED40PS-22-8CSA-VDIM /G2 /FC1-PIR

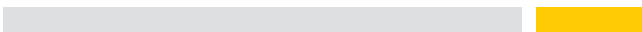

FIXTURE WITH NO FACTORY-INSTALLED ACCESSORIES

KT-BPLED40PS-22-8CSA-VDIM /G2

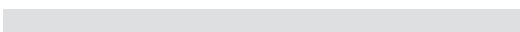

KEYSTONE FIXTURE	
CATALOG NUMBER	
KT-BPLED40PS-22-8CSA-VDIM /G2	

SENSORS	
SUFFIX	CATALOG NUMBER
✓ /FC1-PIR	KTSL-FC1-UV-KO-PIR

CORD SETS	
SUFFIX	CATALOG NUMBER
✓ /L715P6	KT-CS-L715P-6-16/3

EMERGENCY BACKUP	
SUFFIX	CATALOG NUMBER
✓ /EM5	KT-EMRG-LED-5C-500-EN /DF

MOUNTS AND BRACKETS	
SUFFIX	CATALOG NUMBER
✓ /JBOX	KT-BPLED-JBOX-1

* When ordering more than one factory-installed accessory, use multiple suffixes as shown in the ordering examples above.
 Note: All accessories can also be ordered separately for field installation using just their regular Catalog Number, UPC, or Easy Code.