



# KTLD-70-UV-SC2800-56-VDIM-W2

## CONSTANT CURRENT PROGRAMMABLE LED DRIVER

### DESCRIPTION

LED Driver | 70W | 120-277V Input | 900-2800mA Programmable Output Current



Class P FC

RoHS Compliant

**10 YEAR**  
LIMITED WARRANTY

<b>TOTAL POWER:</b> 70W	<b>OUTPUT CURRENT:</b> 900-2800mA
<b>INPUT VOLTAGE:</b> 120-277Vac ±10%	<b>DIMMING:</b> 0-10V
<b>INPUT FREQUENCY:</b> 50/60 Hz	<b>WARRANTY:</b> 5 Years



### PRODUCT FEATURES

- Meets FCC Part 15 (Class B) consumer limits
- Short circuit overload and open load protection
- Dimmable with 0–10V dimmer (down to 1% at max. output current)
- THD: < 20%
- Auxiliary Power: 12Vdc; 200mA max.
- -40°C/–40°F to 50°C/122°F operating temperature
- 90°C/194°F maximum case temperature
- Input frequency: 50/60 Hz
- Programmable output current via Keystone supplied programming jig
- Class A Sound Rating

### PROGRAMMING FEATURES

- Drive Current (10mA Increments)
- Minimum Dimming Level (1%,3%, 5%,7%, or 10%)
- Dimming Curve (Linear, Log, Inverse Log, or Square-law)
- Minimum Dimming Voltage (1V, 1.5V, or 2V)
- Maximum Dimming Voltage (7V, 8V, or 9V)
- Dim-to-off Voltage (.8V, 1V, 1.2V, or N/A)
- Thermal Foldback Temperature (75°C, 80°C, 85°C, or 90°C)



### REQUIRED ACCESSORIES

Order Code	Description
KTLD-SC-ADPT-1E	W2 Case Adapter for Smart Current Programming Cradle
KTLD-SC-PGMR-1	Smart Current Programming Cradle with Micro-USB Cable

### ELECTRICAL SPECIFICATIONS

<b>Input Voltage Range</b>	120-277Vac ±10%
<b>Frequency</b>	50/60 Hz
<b>Power Factor</b>	>0.9 under 120~277Vac Input with 80~100% Load Condition (For All Output Currents)
<b>Inrush Current</b>	20A @277V
<b>Max. Input Current</b>	TBD
<b>THD</b>	< 20% under 120~277Vac input with 80~100% load condition (For All Output Currents)
<b>Load Regulation</b>	± 2%
<b>Line Regulation</b>	± 1%
<b>Output Tolerance</b>	± 5% at Full Load Condition
<b>Turn-On Delay Time</b>	< 2 Seconds at Full Load Condition
<b>Overshoot</b>	< 10% at Full Load Condition
<b>No Load Power Consumption</b>	< 1.5W
<b>Ripple and Noise (pk-pk)</b>	< 3%
<b>Withstand Voltage</b>	Input to output, 2,800Vdc, 2mA
<b>Leakage Current</b>	Maximum 0.5mA at 277Vac, 60Hz input
<b>Protection</b>	<ul style="list-style-type: none"> <li>• <b>Over Voltage Protection:</b> Hiccup mode. Protection will trigger when load voltage exceed specified output voltage and will auto recover after the fault mode is removed.</li> <li>• <b>Over Current Protection:</b> Hiccup mode. Protection will trigger when load current exceed specified output current and will auto recover after the fault mode is removed.</li> <li>• <b>Short Circuit Protection:</b> Hiccup mode. Protection will trigger when short circuit and will auto recover after the fault mode is removed.</li> <li>• <b>Over Temperature Protection:</b> Protection will trigger when driver overheat and auto-recovery when cooled down.</li> </ul>



# KTLD-70-UV-SC2800-56-VDIM-W2

## CONSTANT CURRENT PROGRAMMABLE LED DRIVER

### PRODUCT SPECIFICATIONS

Max. Output Power	Output Current	Output Voltage	OCV	Typical Efficiency at 120V	Typical Efficiency at 240V	Typical Efficiency at 277V	Remote Mounting Distance (#18 AWG)	Class 2	
								US	Canada
70W	900-2800mA	10-56V	60V	TBD	TBD	TBD	13 ft.	3	

### PHYSICAL SPECIFICATIONS

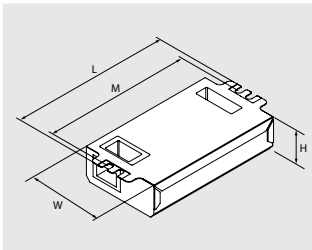

<b>LENGTH</b>	5.00"
<b>WIDTH</b>	3.00"
<b>HEIGHT</b>	1.38"
<b>MOUNTING</b>	4.82"
<b>CASE STYLE</b>	W2
<b>CASE MATERIAL</b>	Metal

### WIRING SPECIFICATIONS

<b>INPUT</b>	Terminal Block
<b>OUTPUT</b>	Terminal Block
<b>DIMMING</b>	Terminal Block

### WIRE SPECIFICATIONS

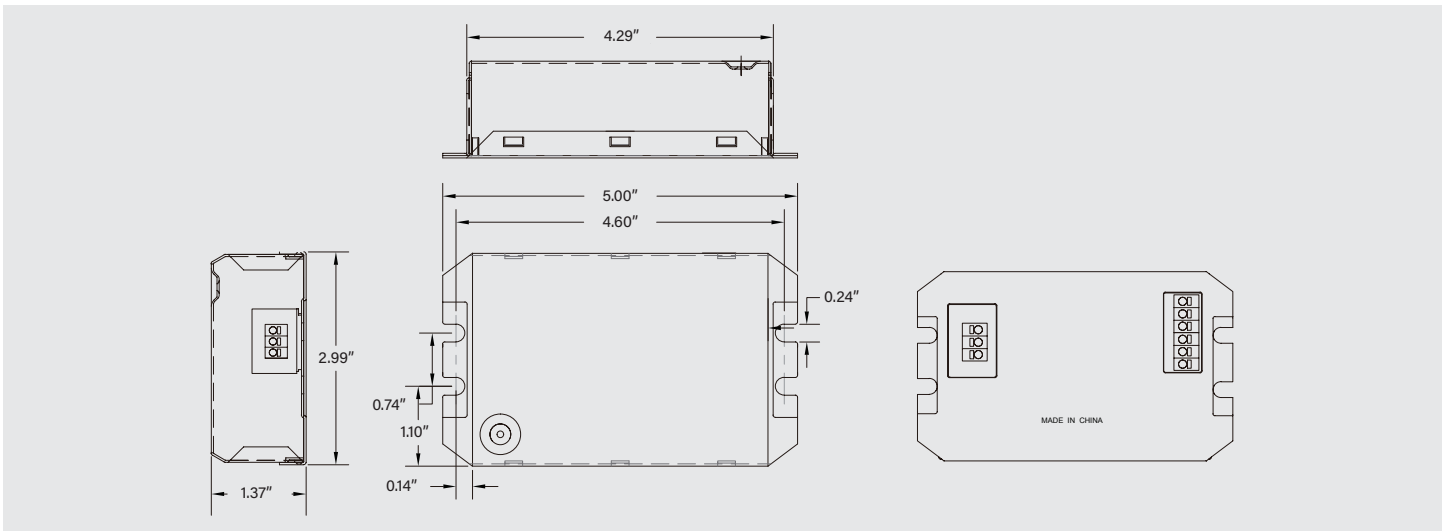

### WIRE DIAGRAM

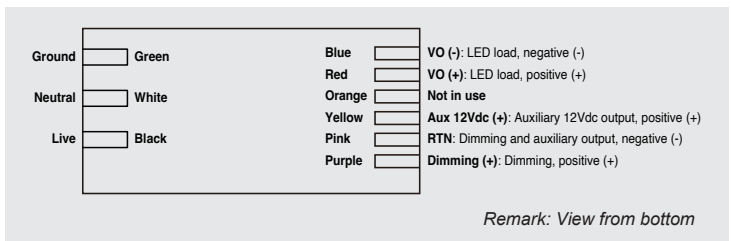



# KTLD-70-UV-SC2800-56-VDIM-W2

## CONSTANT CURRENT PROGRAMMABLE LED DRIVER

### LIFETIME VS CASE TEMPERATURE

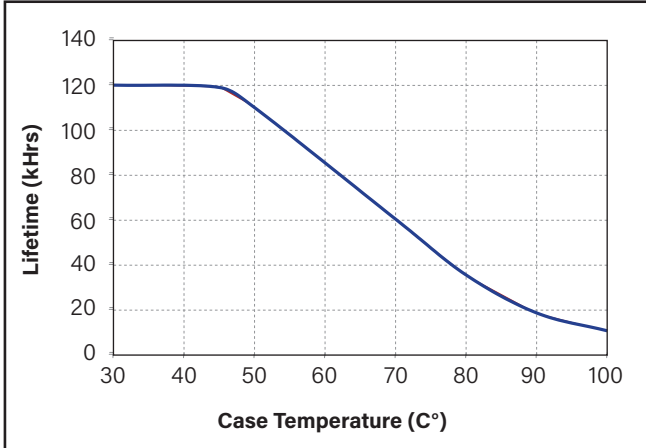

### POWER DERATING VS CASE TEMPERATURE

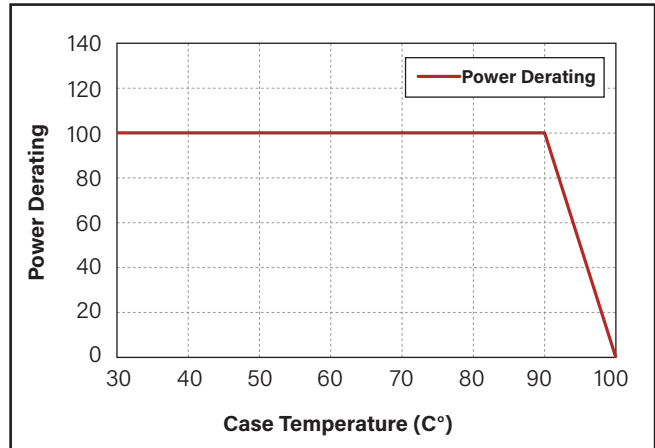

### LED DRIVER OUTPUT WINDOW

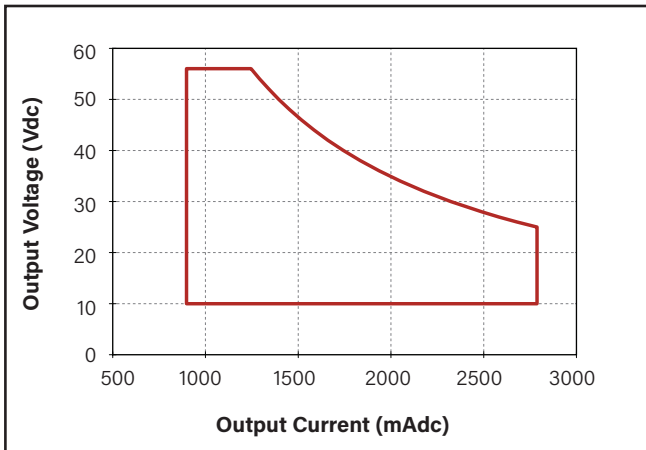

### DIMMING CURVE

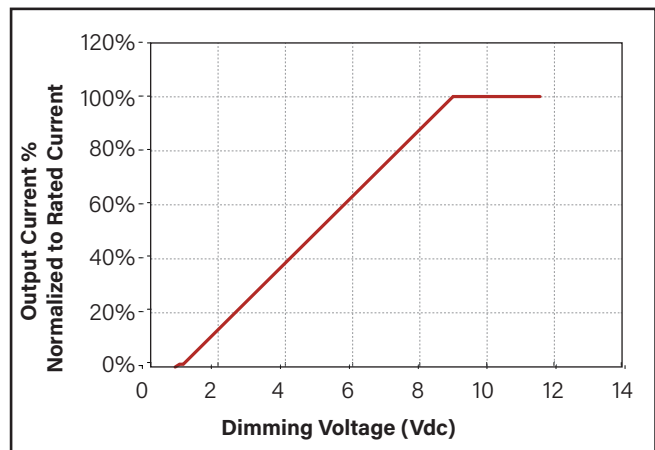



# KTLD-70-UV-SC2800-56-VDIM-W2

## CONSTANT CURRENT PROGRAMMABLE LED DRIVER

### ENVIRONMENTAL SPECIFICATIONS

Operating Temperature	-40 to 50°C
Storage Temperature	-40 to 85°C
Humidity	5% to 95%
MTBF	TBD
Life Rating	85,000 hours at 120Vac input, 100% load and 60°C case temperature
Maximum Case Temperature	90°C
Maximum Case Temperature (tc) for 5-Year Warranty	75°C/167°F

### SAFETY AND EMC COMPLIANCE

UL/cUL	UL 8750 Pending, Class P, UL1310 Class 2
CE	EN61347-1, EN61347-2-13
FCC, 47CFR Part 15	ANSI C63.4:2009 Class B (Consumer Limit)
EN61000-3-2	Harmonic Current Emissions Class C

### ORDERING INFORMATION

Order Code	Packaging Style	UPC	EASY CODE
KTLD-70-UV-SC2800-56-VDIM-W2	Carton Pack	843654151649	HPR-66

### CATALOG NUMBER BREAKDOWN

**KTLD-70-UV-SC2800-56-VDIM-W2**

1 2 3 4 5 6 7 8

- 1 Keystone Technologies LED Driver
- 2 Max. Output Wattage
- 3 120-277V Input
- 4 Smart Current
- 5 Max. Output Current
- 6 Max. Output Voltage
- 7 0-10V Dimming
- 8 Case Style