



KTAT-150-480-277-OC

STEP DOWN AUTO-TRANSFORMER

DESCRIPTION

Auto-transformer (Non-Isolated) | 480-347V Input | 277V Output



INPUT VOLTAGE: 480/347Vac ± 10%
INPUT FREQUENCY: 50/60 Hz
MAXIMUM POWER: 150VA
WARRANTY: 5 Years

ELECTRICAL SPECIFICATIONS

Input Voltage Range	480/347Vac ± 10%
Frequency	50/60 Hz
Output Characteristics	150VA @277V output, 125VA @240V output
Max. Input Current	0.33A @480V with 100% load condition / 0.051A @480V with open load condition 0.45A @347V with 100% load condition / 0.061A @347V with open load condition
Efficiency	95% typical
No Load Power Consumption	<8W
Withstand Voltage	Input to output, 2,000Vac, 10mA
Sound Rated	A
UL/cUL	UL 5085
Maximum Case Temperature	105°C/221°F

PHYSICAL SPECIFICATIONS

Length	2.76"	Mounting	2.17"
Width	2.32"	Unit Weight	1.95 lbs
Height	1.93"	Case Material	Metal

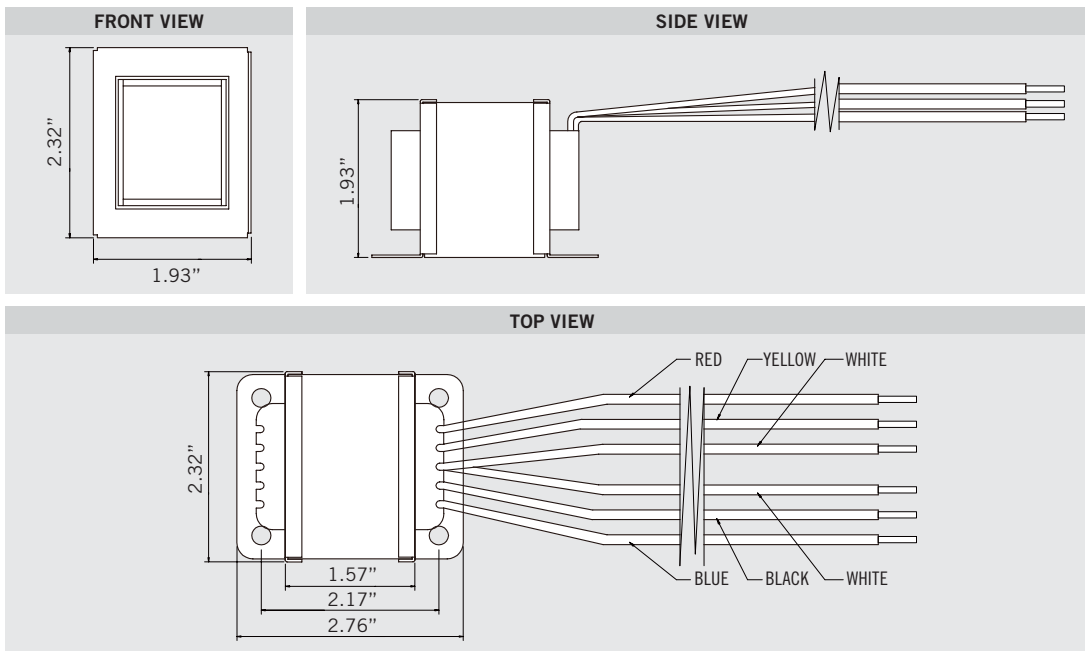



KTAT-150-480-277-OC

STEP DOWN AUTO-TRANSFORMER

WIRING SPECIFICATIONS

Input	14", UL 1316 #18AWG (red, yellow and white)
Output	14", UL 1316 #18AWG (black, blue and white)

WIRING DIAGRAM

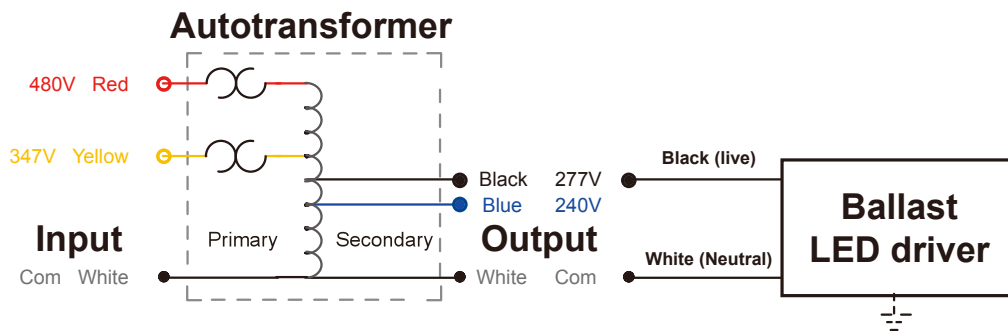

Note:

Wiring for 3-Phase Wye (or star) power supply, connect any two phase wires to Autotransformer input.

Wiring for 3-Phase Delta power supply with proper grounding, connect 480V and ground reference legs to Autotransformer input.

ORDERING INFORMATION

ORDER CODE	PACK QTY.	EASY CODE	UPC
KTAT-150-480-277-OC-CP	18	AJH-09	890949020548

PACKAGING

Carton Size	11" x 8.6" x 4.7"
Carton Weight	35 lb

CATALOG NUMBER BREAKDOWN

KTAT-150-480-277-OC-CP

1

2

3

4

5

5

- 1 Keystone Technologies Auto-Transformer
- 2 Max. Power (VA)
- 3 Input Voltage
- 4 Output Voltage
- 5 Open Core
- 6 Packaging Style