

# AL-LED-S1-X-70-8XX-NM

## LED AREA LIGHT FIXTURES



Compact 70W High-Performance LED Area Light,  
120–277V Input, Bronze Housing,  
Multiple Mounting, Optics, and Control options

### PRODUCT FEATURES

- Compact, low-profile design delivers high-performance illumination and improves application site aesthetics
- Heavy-duty, die-cast aluminum housing with ample heat sinking for enhanced thermal performance
- True U0 design for Dark Sky compliant performance eliminates undesirable sky glow
- Integrated NEMA/ANSI C136.10 3-pin twist-lock receptacle with shorting cap, standard on all fixtures, simplifies ordering requirements for photo control needs
- Precision-crafted optics, available with type II, III, IV, and V patterns, to meet diverse requirements from general purpose to specification-grade applications
- Integral latch design for hassle-free, hinged access to driver compartment
- Four contractor-friendly mounting options available (sold separately): slip fitter mount, adjustable pole mount for square and round poles, fixed pole mount for square and round poles, and trunnion mount
- Bi-level occupancy sensors and twist-lock photocell accessories available
- Reversible glare shield available, suitable for backside (house-side) or frontside (street-side) shielding
- Powered by 0–10V dimming LED driver featuring 12V AUX power tap, 6kV surge protection
- Ambient operating temperature: –40°C/–40°F to 50°C/122°F
- UL Certified for wet locations, IP65
- 0–10V dimming, 10% min
- Power factor: >0.95
- THD: <20%
- LED chip lifetime: L70 >100,000 hrs @ 25°C/77°F ambient fixture temp
- Meets FCC Part 15, Part B, Class A standards for conducted and radiated emissions



### ELECTRICAL SPECIFICATIONS

Catalog Number	Wattage	Lumens	Efficacy	Dimming	Color Temp	CRI	Dist Type*	Input Voltage	Rated Life	Legacy Equivalent	Housing Color**	Additional Feature
AL-LED-S1-3-70-840-NM	70W	9,520 lm	136 lm/W	0–10V	4000K	>80	III	120–277V	50,000 hrs	175–250W	Bronze	10kV external surge protection included
AL-LED-S1-3-70-850-NM		9,660 lm	138 lm/W		5000K		III					
AL-LED-S1-5-70-840-NM		9,590 lm	137 lm/W		4000K		V					
AL-LED-S1-5-70-850-NM		9,730 lm	139 lm/W		5000K		V					

\* Fixtures with Type 2 (II) and Type 4 (IV) optics are available and assembled to order. Lead times may apply. Please see catalog number breakdown for full ordering code details.

\*\* Fixtures (and mounts) with alternate housing colors are available and made to order. Extended lead times apply. Please see catalog number breakdown for full ordering code details.

# AL-LED-S1-X-70-8XX-NM

## LED AREA LIGHT FIXTURES

### MOUNTING BRACKET OPTIONS (SOLD SEPARATELY)

#### SLIP FITTER MOUNT

Fits 2 3/8" tenon; Bronze

Catalog Number	UPC	Easy Code
KT-ALED-SF-1-KIT	843654131641	JRH-74



#### ADJUSTABLE POLE MOUNT

For round or square pole; Bronze

Catalog Number	UPC	Easy Code
KT-ALED-PMA-1-KIT	843654131634	DAQ-87



#### FIXED POLE MOUNT

For round or square pole; Bronze

Catalog Number	UPC	Easy Code
KT-ALED-PM-1-KIT	843654131627	QVG-29



#### TRUNNION MOUNT

Bronze

Catalog Number	UPC	Easy Code
KT-ALED-TM-1-KIT	843654131658	GTH-37

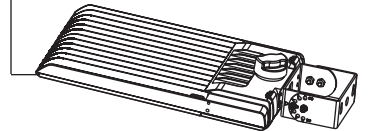
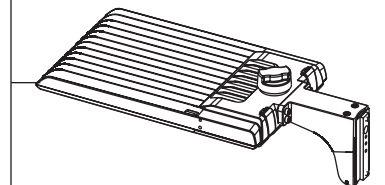
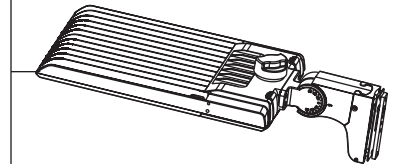
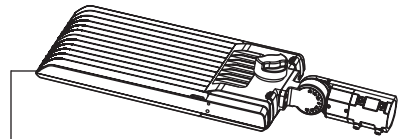
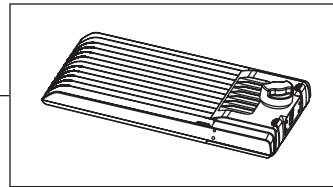
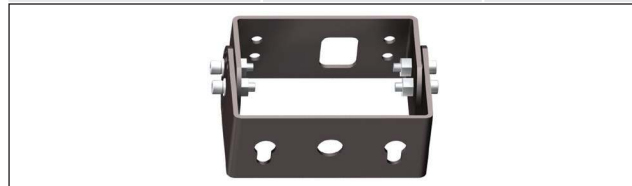

# AL-LED-S1-X-70-8XX-NM

## LED AREA LIGHT FIXTURES

### PHYSICAL SPECIFICATIONS

#### LED AREA LIGHT FIXTURE

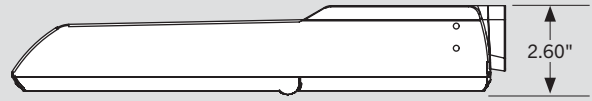
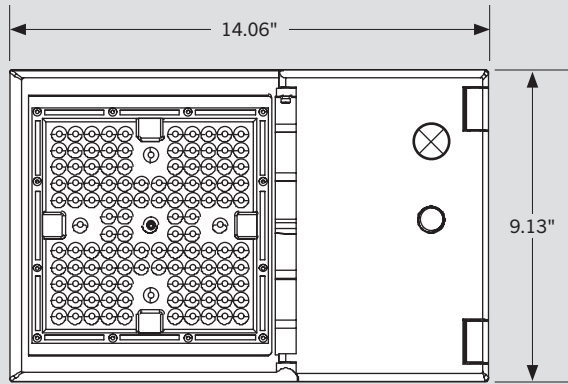

### PACKAGING

Carton Quantity	1 piece
Carton Dimensions	6.1"H x 11.22"W x 22.63"L
Carton Weight	7.28 lbs

### POLE MOUNT (ADJUSTABLE OR FIXED) DRILLING HOLES

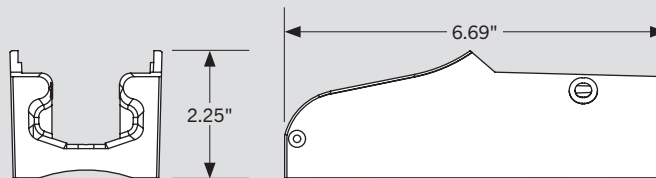
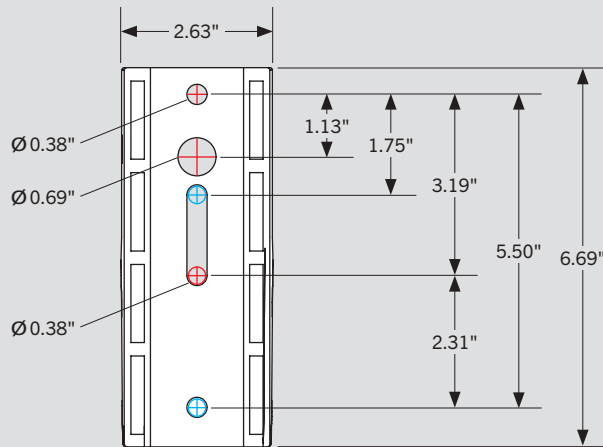

# AL-LED-S1-X-70-8XX-NM

## LED AREA LIGHT FIXTURES

### WIRING DIAGRAM

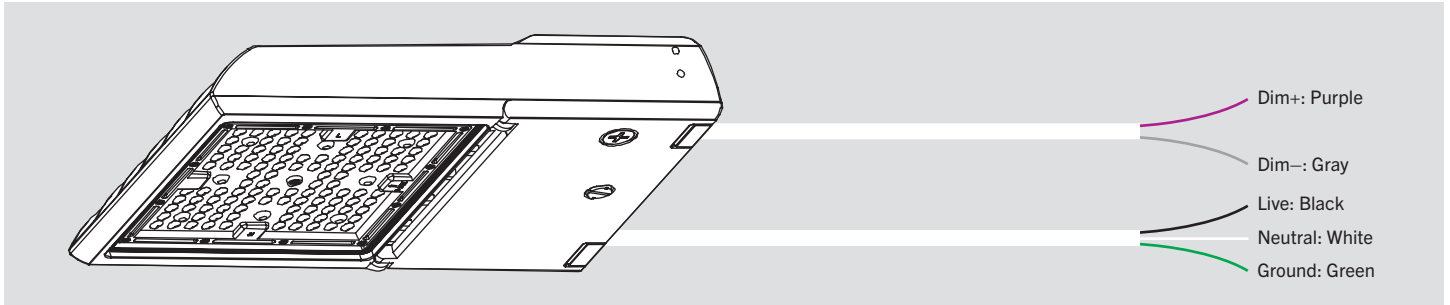

### LIGHT DISTRIBUTION PATTERN

#### TYPE 3 (III)

Pole-mount view from above; Area light mounted at 20'

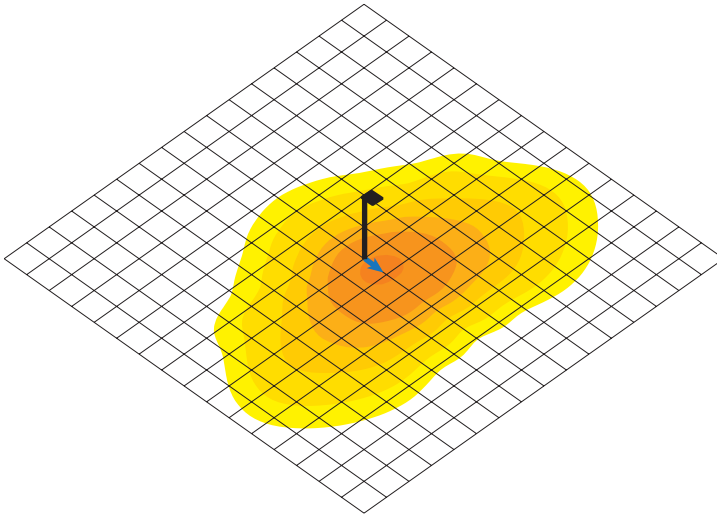

#### TYPE 5 (V)

Pole-mount view from above; Area light mounted at 20'

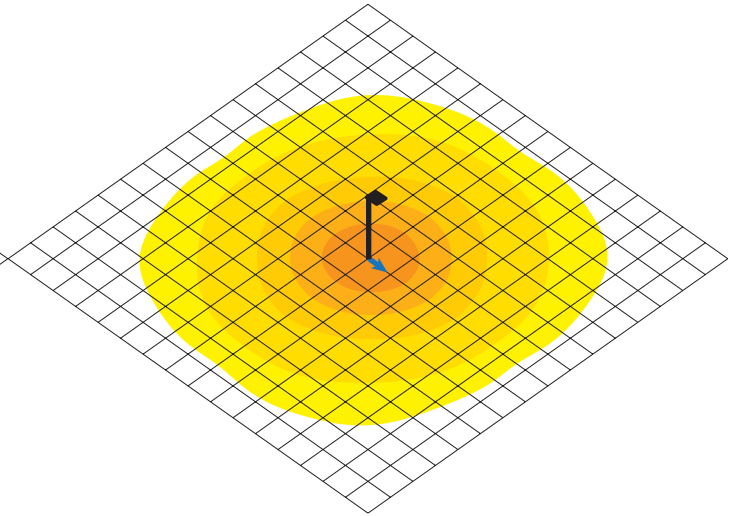

- Photometric layout for general reference only
- Grid dimension: 10 × 10 sq ft

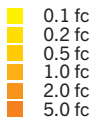

- Photometric layout for general reference only
- Grid dimension: 10 × 10 sq ft

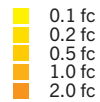

# AL-LED-S1-X-70-8XX-NM

## LED AREA LIGHT FIXTURES

### PHOTOMETRIC SPECIFICATIONS (TYPE 3 [III])

#### ISOCANDELA PLOT

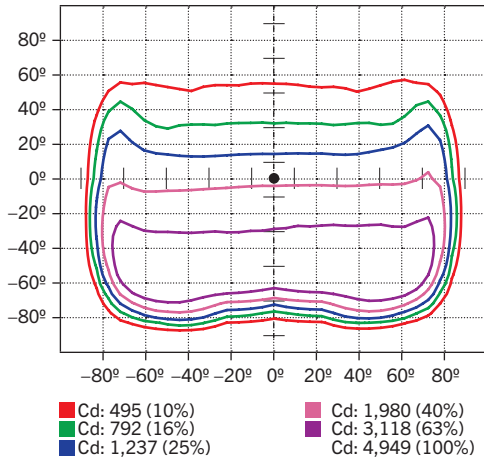

#### LUMINOUS INTENSITY DISTRIBUTION

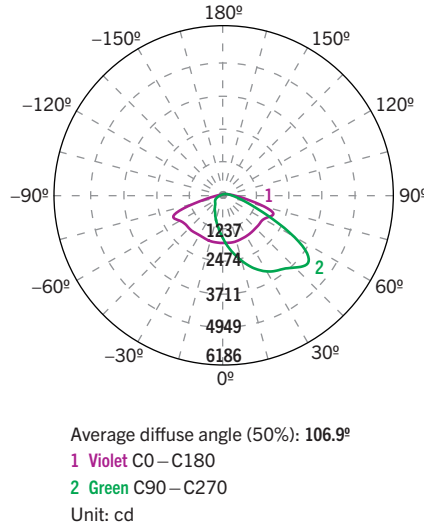

#### FLUX DISTRIBUTION

Zone	Lumens	% Luminaire
<b>Forward Light</b>	7,326 lm	78.8%
0°–30°	1,026 lm	11.0%
30°–60°	3,807 lm	40.9%
60°–80°	2,397 lm	25.8%
80°–90°	95 lm	1.0%
<b>Back Light</b>	1,973 lm	21.2%
0°–30°	529 lm	5.7%
30°–60°	925 lm	9.9%
60°–80°	485 lm	5.2%
80°–90°	33 lm	0.4%
<b>Up Light</b>	0,000 lm	00.0%
90°–100°	000 lm	0.0%
100°–180°	000 lm	0.0%

#### BUG\* Rating

Asymmetrical Luminaire Types	
Type I, II, III, IV	B2 U0 G2
Quadrilateral Symmetrical Luminaire Types	
Type V, Area Light	B2 U0 G2

\* Backlight, Uplight, Glare

### PHOTOMETRIC SPECIFICATIONS (TYPE 5 [V])

#### ISOCANDELA PLOT

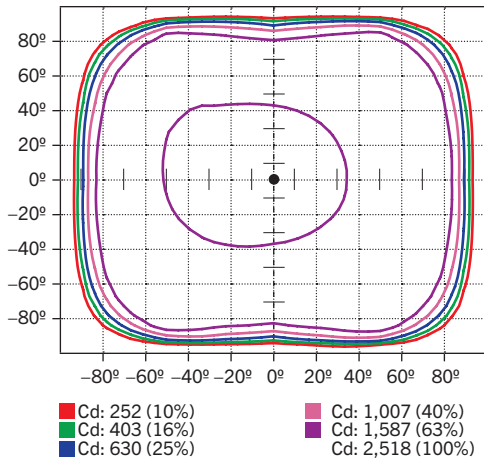

#### LUMINOUS INTENSITY DISTRIBUTION

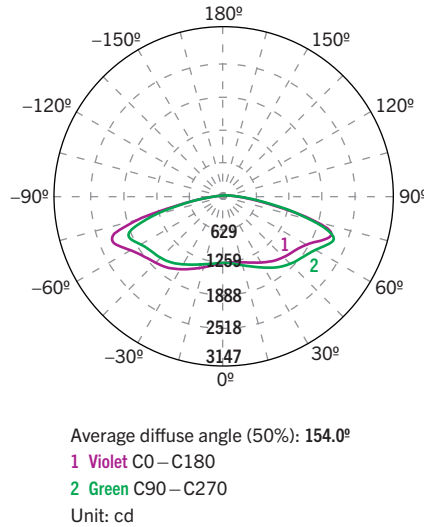

#### FLUX DISTRIBUTION

Zone	Lumens	% Luminaire
<b>Forward Light</b>	4,801 lm	51.5%
0°–30°	586 lm	6.3%
30°–60°	1,969 lm	21.1%
60°–80°	2,001 lm	21.5%
80°–90°	244 lm	2.6%
<b>Back Light</b>	4,517 lm	48.5%
0°–30°	578 lm	6.2%
30°–60°	1,898 lm	20.4%
60°–80°	1,857 lm	19.9%
80°–90°	184 lm	2.0%
<b>Up Light</b>	0 lm	0.0%
90°–100°	0 lm	0.0%
100°–180°	0 lm	0.0%

#### BUG\* Rating

Asymmetrical Luminaire Types	
Type I, II, III, IV	B3 U0 G3
Quadrilateral Symmetrical Luminaire Types	
Type V, Area Light	B3 U0 G3

\* Backlight, Uplight, Glare

# AL-LED-S1-X-70-8XX-NM

## LED AREA LIGHT FIXTURES

### PHOTOMETRIC SPECIFICATIONS (TYPE 4 [IV])

#### ISOCANDELA PLOT

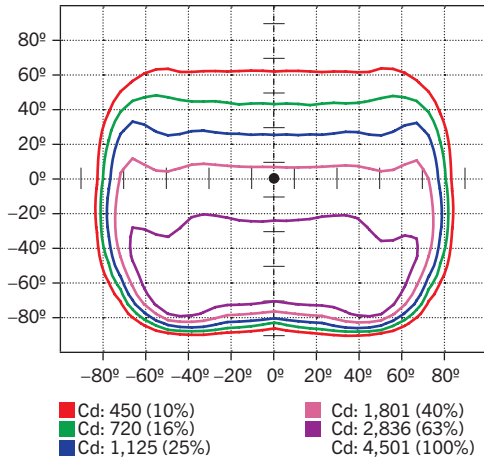

#### LUMINOUS INTENSITY DISTRIBUTION

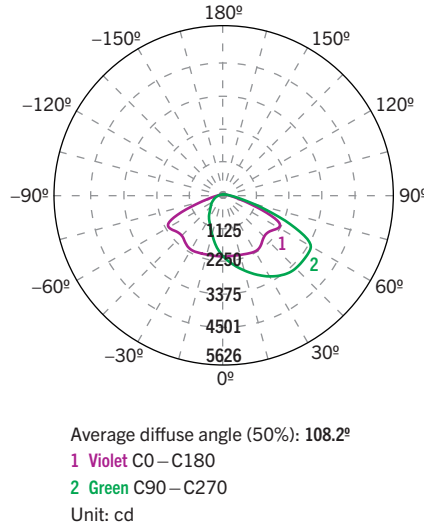

#### FLUX DISTRIBUTION

Zone	Lumens	% Luminaire
<b>Forward Light</b>	7,021 lm	75.8%
0°–30°	1,068 lm	11.5%
30°–60°	3,500 lm	37.8%
60°–80°	2,355 lm	25.4%
80°–90°	97 lm	1.1%
<b>Back Light</b>	2,246 lm	24.2%
0°–30°	645 lm	7.0%
30°–60°	1,120 lm	12.1%
60°–80°	457 lm	4.9%
80°–90°	25 lm	0.3%
<b>Up Light</b>	0 lm	0.0%
90°–100°	0 lm	0.0%
100°–180°	0 lm	0.0%

#### BUG\* Rating

##### Asymmetrical Luminaire Types

Type I, II, III, IV B2 U0 G2

##### Quadrilateral Symmetrical Luminaire Types

Type V, Area Light B2 U0 G2

\* Backlight, Uplight, Glare

### PHOTOMETRIC SPECIFICATIONS (TYPE 2 [II])

#### ISOCANDELA PLOT

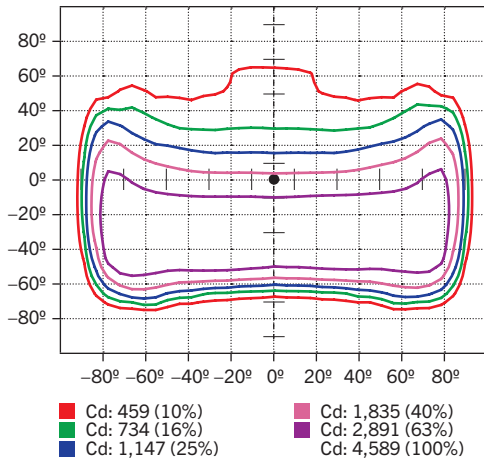

#### LUMINOUS INTENSITY DISTRIBUTION

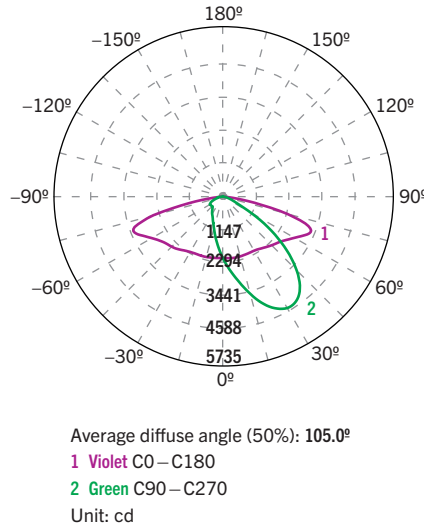

#### FLUX DISTRIBUTION

Zone	Lumens	% Luminaire
<b>Forward Light</b>	7,262 lm	76.9%
0°–30°	1,332 lm	14.1%
30°–60°	4,057 lm	43.0%
60°–80°	1,780 lm	18.8%
80°–90°	93 lm	1.0%
<b>Back Light</b>	2,184 lm	23.1%
0°–30°	560 lm	5.9%
30°–60°	989 lm	10.5%
60°–80°	594 lm	6.3%
80°–90°	41 lm	0.4%
<b>Up Light</b>	0 lm	0.0%
90°–100°	0 lm	0.0%
100°–180°	0 lm	0.0%

#### BUG\* Rating

##### Asymmetrical Luminaire Types

Type I, II, III, IV B2 U0 G2

##### Quadrilateral Symmetrical Luminaire Types

Type V, Area Light B2 U0 G1

\* Backlight, Uplight, Glare













# AL-LED-S1-X-70-8XX-NM

## LED AREA LIGHT FIXTURES

### EPA SPECIFICATIONS

#### Small-Size Fixture Housing

Conditions: Horizontal winds only for calculations. Worst case total projected area used for calculations. All drag coefficients are set as worst case 1.2. For details on exact EPA calculations and assumptions, please contact your sales representative.

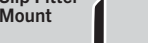
EPA Calcs (1.2*ft <sup>2</sup>   View)		Single Fixture	2 Fixtures at 90°	2 Fixtures at 180°	3 Fixtures at 90°	3 Fixtures at 120°	4 Fixtures at 90°	2 Fixtures Side-by-Side	3 Fixtures Side-by-Side	4 Fixtures Side-by-Side
Mounting Application	Fixture Position									
Adjustable Pole Mount 	Horizontal	0.50 sq. ft.	0.73 sq. ft.	1.00 sq. ft.	1.17 sq. ft.	1.21 sq. ft.	1.17 sq. ft.	0.56 sq. ft.	0.85 sq. ft.	1.13 sq. ft.
Adjustable Pole Mount 	45°	0.93 sq. ft.	1.41 sq. ft.	1.00 sq. ft.	1.89 sq. ft.	2.57 sq. ft.	1.89 sq. ft.	1.86 sq. ft.	2.78 sq. ft.	3.71 sq. ft.
Slip Fitter Mount 	Horizontal	0.48 sq. ft.	0.81 sq. ft.	0.96 sq. ft.	1.28 sq. ft.	1.31 sq. ft.	1.28 sq. ft.	0.69 sq. ft.	1.04 sq. ft.	1.38 sq. ft.
Slip Fitter Mount 	45°	1.00 sq. ft.	1.48 sq. ft.	1.00 sq. ft.	1.94 sq. ft.	2.63 sq. ft.	1.96 sq. ft.	2.00 sq. ft.	3.00 sq. ft.	4.00 sq. ft.
Slip Fitter Mount 	Vertical	1.32 sq. ft.	1.79 sq. ft.	1.32 sq. ft.	2.27 sq. ft.	2.70 sq. ft.	2.27 sq. ft.	2.64 sq. ft.	3.95 sq. ft.	5.27 sq. ft.

### ORDERING INFORMATION

ORDER CODE	PACK QTY.	UPC	Easy Code
AL-LED-S1-3-70-840-NM	1	843654125489	00J-42
AL-LED-S1-3-70-850-NM	1	843654135496	BLA-01
AL-LED-S1-5-70-840-NM	1	843654135502	NHA-40
AL-LED-S1-5-70-850-NM	1	843654125519	NQN-27