

PRODUCT FEATURES

- ANSI Designation: M137 or M152
- Line Voltage: 120/208/240/277
- Regulation: 10%
- Frequency: 60 Hz
- Recommended Fuse (A): 5/3/3/2
- Circuit Type: CWA
- Insulation Class: 180°C
- Capacitor Value: 11 MF
- Capacitor Voltage Rating: 370 V
- Capacitor Temperature Rating: 90°C
- Winding Materials: Cu/Cu
- Lamp Starter: XG-04
- Agency Certification: RU, cRU
- Maximum Distance to Lamp: N/A
- 2 Year Warranty

LAMP TYPE: 175W MH-PS

INPUT VOLTAGE: Quad Tap (120/208/240/277)

CIRCUIT TYPE: CWA

ELECTRICAL SPECIFICATIONS

LINE VOLT (V)	POWER FACTOR	LINE CURRENT			INPUT POWER (W)	OPEN CIRCUIT VOLTAGE (V)	MINIMUM START TEMP	UL TEMP CODE	WIRING DIAGRAM
		OPERATING	OPEN	START					
120	High	1.70	1.74	1.26	205	290	-30°C	A	H3
208	High	0.99	1.01	0.64	205	290	-30°C	A	H3
240	High	0.86	0.88	0.53	205	290	-30°C	A	H3
277	High	0.74	0.76	0.47	205	290	-30°C	A	H3

WIRING DIAGRAMS

DIAGRAM H3

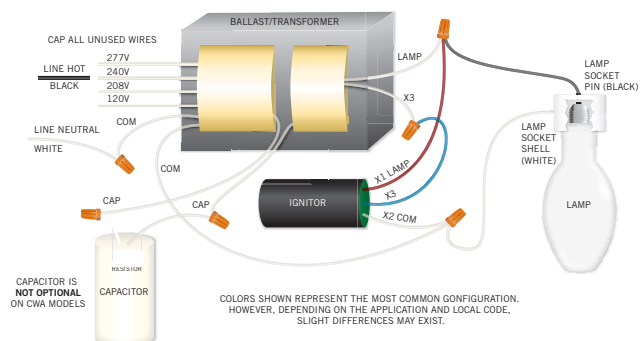
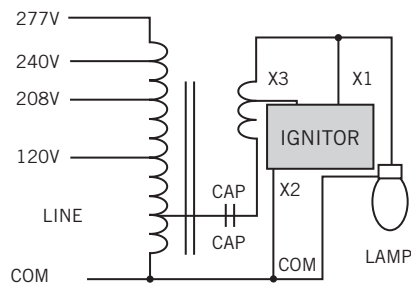

CASE STYLE/DIMENSIONS

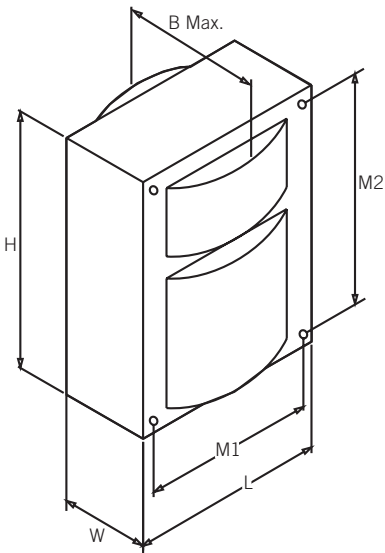

OVERALL DIMENSIONS

LENGTH: 2.81"
WIDTH: 3.07"
HEIGHT: 3.94"
B MAX: 4.85"

MOUNTING HOLES

DIAMETER: 0.25"
M1: 2.44"
M2: 3.50"

BRACKET DIMENSIONS

LENGTH: 5.50"
WIDTH: 1.18"

LEAD LENGTH: 12-14"

BALLAST NET WEIGHT: 9.35 lbs

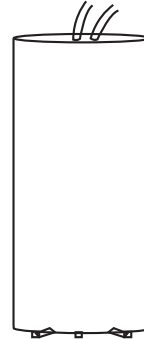

CAPACITOR INFO

WATTAGE: 175
MICROFARAD: 11
VOLTAGE: 370V
TYPE: Dry Film



IGNITOR INFO

LAMP TYPE: Pulse Start Metal Halide
WATTAGE: 175
TYPE:

ORDERING INFORMATION

ORDER CODE	PACKAGING STYLE	PACK QTY.	ITEM STATUS
MPS-175A-Q-KIT		1	Quick Ship
*Kit Includes: Pre-Wired Ballast, Capacitor, Ignitor, Mounting Brackets, Mounting Hardware			

CATALOG NUMBER BREAKDOWN

MPS-175A-Q-KIT

