

# LED45PSHID-H-E26-8CSB-D

## HORIZONTAL HID POWER AND COLOR SELECT LED LAMP

### DESCRIPTION

45W HID Replacement LED Lamp Designed for Horizontal Applications  
 Power Select | Color Select | 80 CRI | IP64



<b>LAMP TYPE:</b> Horizontal HID LED Lamp
<b>BASE TYPE:</b> E26 (Medium) Rotatable
<b>WATTAGE:</b> 45/36/27W
<b>COLOR TEMPERATURE:</b> 3000/4000/5000K
<b>METAL HALIDE EQUIVALENT:</b> 175W
<b>COLOR RENDERING INDEX (CRI):</b> >80
<b>WARRANTY:</b> 5 Years

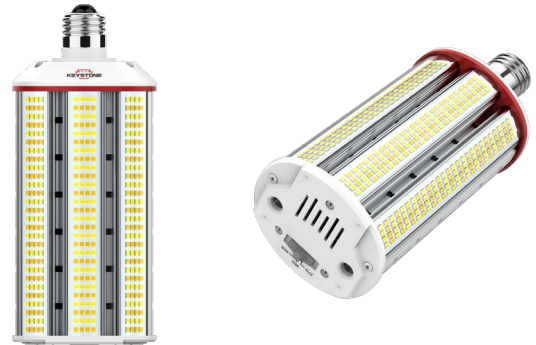

### PRODUCT FEATURES

- Replacement for conventional metal halide lamp
- Optimized for horizontal applications, ideal for wall pack retrofits
- Environmentally friendly: No mercury used
- Instant startup
- Integral driver eliminates the need for external driver or legacy ballast; includes 4kV surge protection
- Not for use with standard dimmers; see instructions
- 50,000+ hour lifetime
- Operating temperature: 30°C/-22°F - 45°C/113°F
- Suitable for use in enclosed fixtures
- Minimum lamp compartment dimensions: 8" x 8" x 8.7"
- UL listed
- IP64 rated; integrated heat sink quickly dissipates heat and guides water intrusion out of the lamp

### PERFORMANCE SPECIFICATIONS

Catalog Number	Input Voltage	Selectable Power	Selectable CCT	Lumens	Efficacy	Input Voltage	Base	DLC	CRI	Metal Halide Equivalent
KT-LED45PSHID-H-E26-8CSB-D	120-277V	45W	3000K	6525	145 lm/W	120-277V	E26	No	>80	175W MH
			4000K	6975	155 lm/W					
			5000K	6615	147 lm/W					
		36W	3000K	5510	153 lm/W					
			4000K	5725	159 lm/W					
			5000K	5580	155 lm/W					
		27W	3000K	4185	155 lm/W					
			4000K	4345	161 lm/W					
			5000K	4240	157 lm/W					

### SELECTABILITY

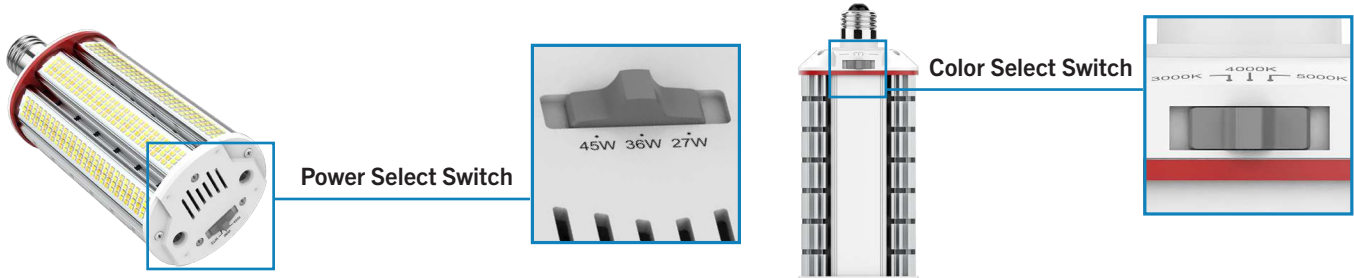

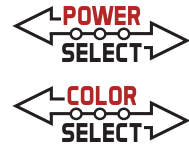

# LED45PSHID-H-E26-8CSB-D

## HORIZONTAL HID POWER AND COLOR SELECT LED LAMP

### PHYSICAL CHARACTERISTICS

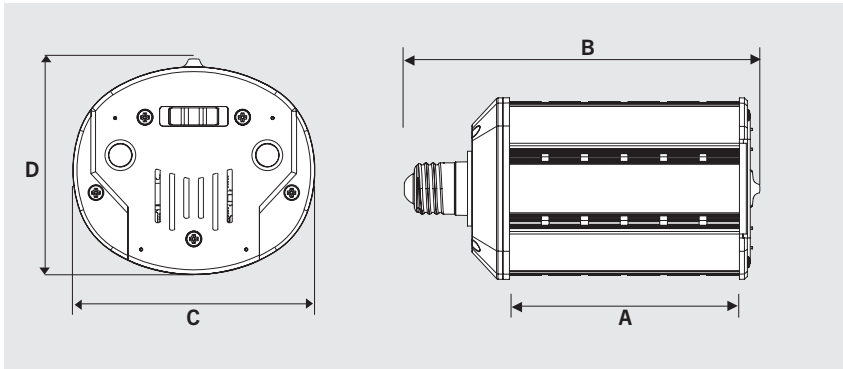

### LAMP DIMENSIONS

A (Illuminated Length)	6.18"
B (Body Length)	8.66"
C (Width)	3.62"
D Diameter	3.23"

**BASE TYPE:** E26 (Medium) Rotatable

### WIRING INSTRUCTIONS

#### STEP 1

**Disconnect power.** Disconnect and remove existing ballast, capacitor, and/or ignitor (where applicable) from fixture.

#### STEP 2

Rewire for line voltage to the lamp socket. Lamp is compatible with 120-277V from single phase, three phase wye, and three phase delta systems.

#### STEP 3

Install new LED replacement lamp. Ensure lamp is operating properly when power is turned on.

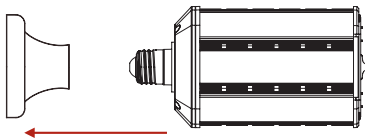

#### STEP 1

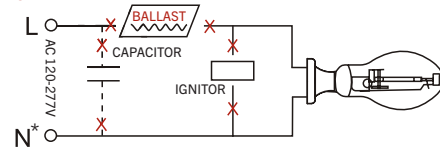

#### STEP 2

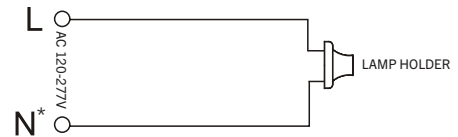

#### STEP 3

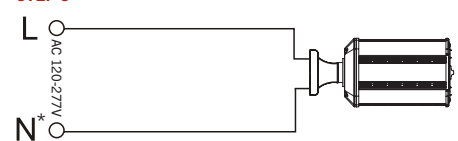

\*or other line for certain three phase systems such as 120/208 three phase wye systems

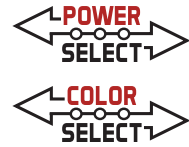

# LED45PSHID-H-E26-8CSB-D

## HORIZONTAL HID POWER AND COLOR SELECT LED LAMP

**ORDERING INFORMATION**

ORDER CODE	PACK QTY.	EASY CODE	UPC
LED45PSHID-H-E26-8CSB-D	12	NCU-18	843654138893

**CATALOG NUMBER BREAKDOWN**

# KT-LED45PSHID-H-E26-8CSB-D

1 2 3 4 5 6 7 8 9 10 11

- 1 Keystone Technologies
- 2 LED Lamp
- 3 Max Wattage
- 4 Power Select
- 5 Lamp Type
- 6 Orientation
- 7 Base Type
- 8 80 CRI
- 9 Color Select
- 10 Color Select Designation
- 11 Direct Drive

**10 Color Select Designation**

B	3000/4000/5000K
---	-----------------