



# XFIT



## KT-WPLED80-M1-8CSB-VDIM-W

### TRADITIONAL NON-CUTOFF LED WALL PACK

#### DESCRIPTION

Traditional 80W Non-Cutoff LED Wall Pack | 120-277V Input | 3000-5000K | Medium-Size Housing | White Finish | Glass Lens

#### APPLICATION

Building mount for exterior illumination (perimeters, pathways, loading docks, and other general security lighting requirements)

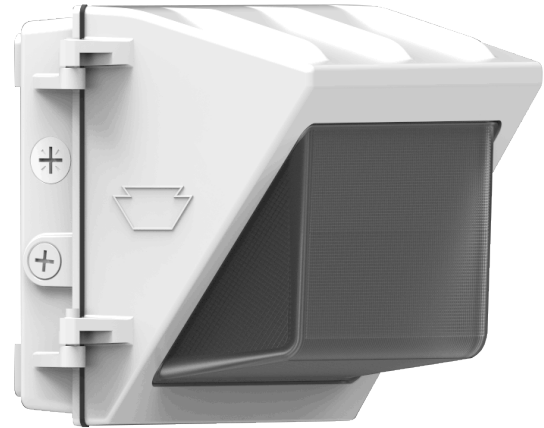

**10 YEAR**  
LIMITED WARRANTY

#### PRODUCT FEATURES

- Keystone Color Select technology (3000/4000/5000K)
- Traditional design that matches appearance and light distribution pattern of legacy HID fixtures. Optimized for one-for-one replacements
- Heavy duty die cast aluminum housing with (5) 1/2" threaded conduit hubs: (1) on back and (1) on all four sides
- Powered by Keystone 0-10V dimming LED drivers
- Built-in dusk-to-dawn photocell behind translucent 3/4" threaded plug with anti-yellowing agent
- Borosilicate glass lens diffuses light source and provides uniform distribution
- Covers footprint of mid-size HID wallpacks
- Ambient operating temperature: -40°C/-40°F to 50°C/122°F
- UL Certified for wet locations; IP65 rated
- Fixture impact rating IK06
- Power Factor: >0.95
- THD: <20%
- LED chip lifetime: L70 >100,000 hrs @ 25°C/77°F ambient fixture temperature
- Meets FCC Part 15, Part B, Class A standards for conducted and radiated emissions
- **Compatible with Keystone LED Emergency Backups. See Accessories page for more details**

#### PRODUCT SPECIFICATIONS

Catalog Number	Wattage	Selectable CCT*	Lumens	Lumens Below 90°	Efficacy	Input Voltage	Dimming	CRI	Rated Life	Legacy Equivalent	Housing Color
KT-WPLED80-M1-8CSB-VDIM-W	80W	3000K	10955	9860	137 lm/W	120-277V	0-10V	>80	50,000 hrs	250-320W MH	White
		4000K	11925	10730	149 lm/W						
		5000K	11360	10225	142 lm/W						

\* Color Uniformity: CCT (Correlated Color Temperature) range as per guidelines outlined in ANSI C78.377-2017



# KT-WPLED80-M1-8CSB-VDIM-W

## TRADITIONAL NON-CUTOFF LED WALL PACK

### PHYSICAL SPECIFICATIONS

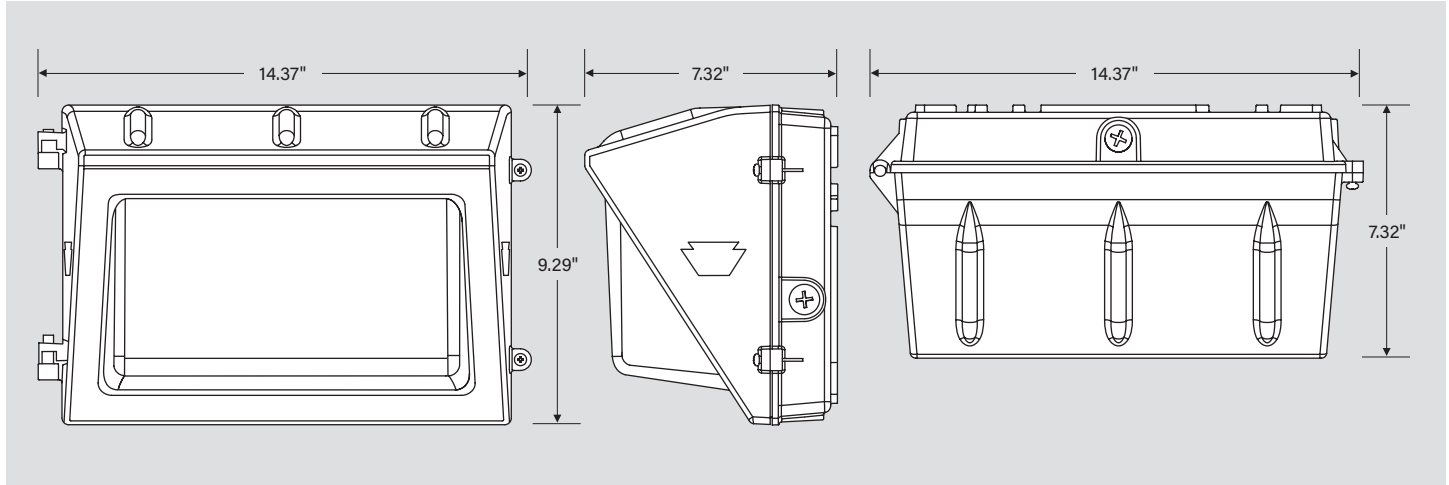

### GENERAL SETUP INSTRUCTIONS

#### GENERAL WIRING DIAGRAM

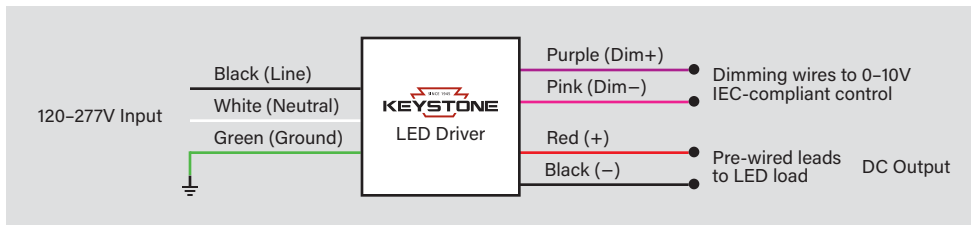

**Caution:** Before installing, make certain that AC power to the fixture is off.

**Caution:** The electrical rating of this product is 120-277V. Installer must confirm that there is 120-277V at the fixture before installation.

#### PHOTOCELL ENABLE / DISABLE

This fixture is equipped with a dusk-to-dawn photocell behind the translucent knock-out (KO) cover. Adjust the dip switch to enable (ON) or disable (OFF) the photocell function (see illustrations to the right). Fixture comes preset with photocell enabled unless otherwise noted.

#### COLOR SELECT (CCT) ADJUSTMENT

This fixture is equipped with Color Select technology. There is an adjustable dip switch behind the translucent knock-out (KO) cover to change CCT between 5000K, 4000K, and 3000K (see illustrations to the right). Fixture comes preset at 5000K unless otherwise noted.

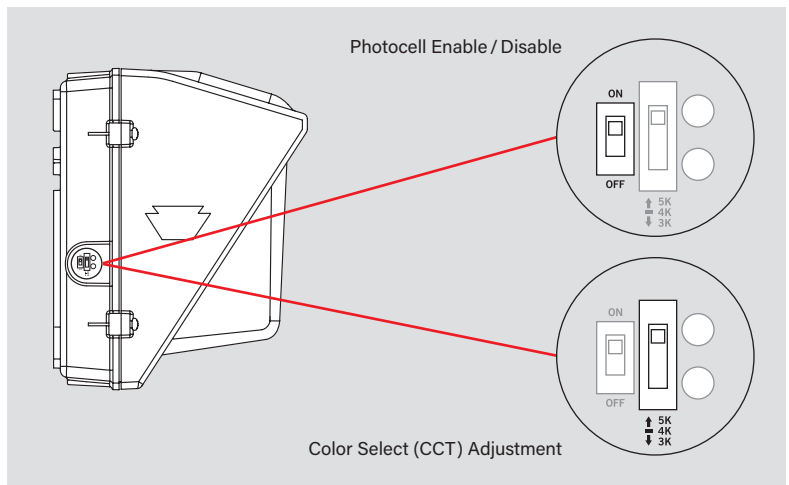

**KT-WPLED80-M1-8CSB-VDIM-W**  
TRADITIONAL NON-CUTOFF LED WALL PACK

**PHOTOMETRIC SPECIFICATIONS**

**ISOCANDELA PLOT**

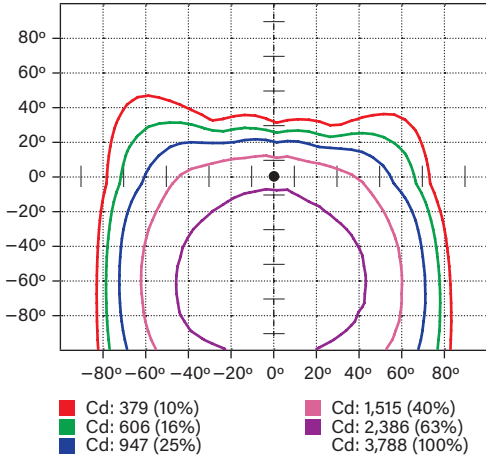

**LUMINOUS INTENSITY DISTRIBUTION**

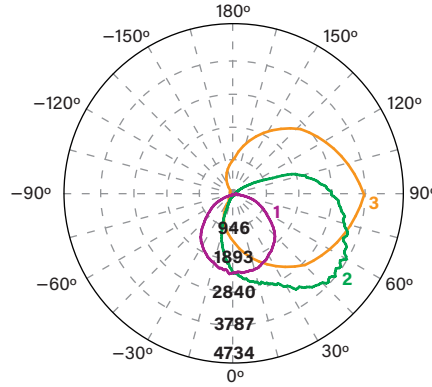

Average diffuse angle (50%): **111.4°**

- 1 Violet C0 - C180
- 2 Green C90 - C270
- 3 Orange G51

Unit: cd

**FLUX DISTRIBUTION**

Zone	Lumens	% Luminaire
<b>Forward Light</b>	8,671 lm	79.6%
0°-30°	1,281 lm	11.8%
30°-60°	3,696 lm	33.9%
60°-80°	2,660 lm	24.4%
80°-90°	1,035 lm	9.5%
<b>Back Light</b>	1,029 lm	9.5%
0°-30°	409 lm	3.8%
30°-60°	471 lm	4.3%
60°-80°	126 lm	1.2%
80°-90°	23 lm	0.2%
<b>Up Light</b>	1,195 lm	11.0%
90°-100°	551 lm	5.1%
100°-180°	644 lm	5.9%

**BUG\* Rating**

**Asymmetrical Luminaire Types**

Type I, II, III, IV      B1 U4 G5

**Quadrilateral Symmetrical Luminaire Types**

Type V, Area Light      B1 U4 G5

\* Backlight, Uplight, Glare

**MOUNTING**

Side view

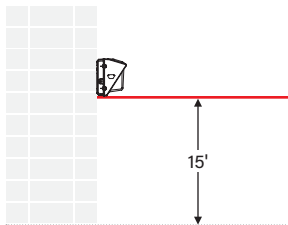

**LIGHT DISTRIBUTION PATTERN**

Isometric view from above; Luminaire mounted at 15'

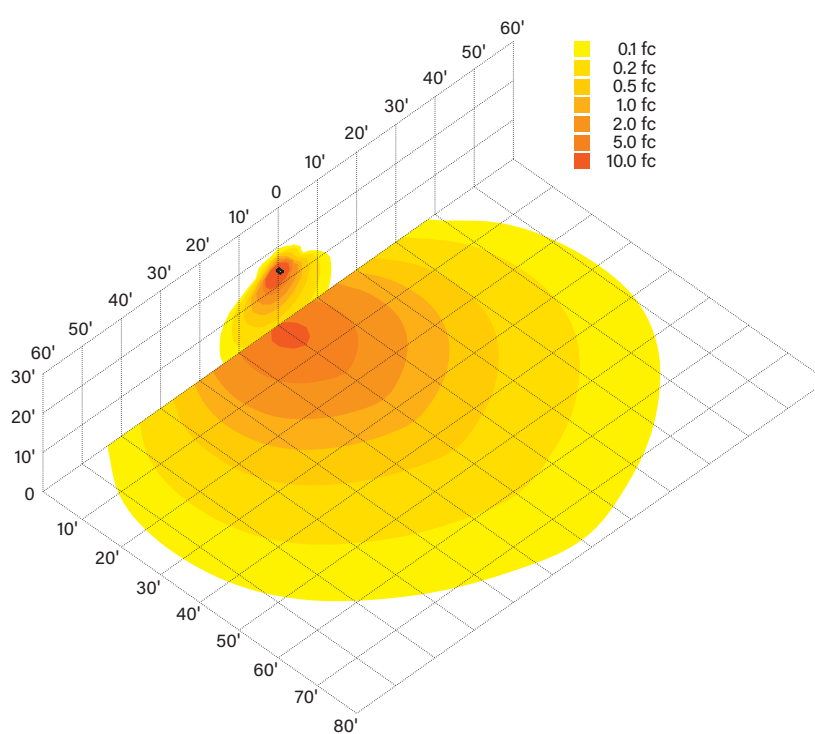

# KT-WPLED80-M1-8CSB-VDIM-W

## TRADITIONAL NON-CUTOFF LED WALL PACK

### ACCESSORIES

#### SENSORS

**Factory-Installable OR Field-Installable** (field-installable purchased separately)

✓	SUFFIX*	CATALOG NUMBER	DESCRIPTION	UPC	EASY CODE
	/MW3	KTS-MW3-UV-KO-K1	Microwave Sensor Kit, Includes 120-277V input to 12V DC convertor & 12V input sensor head, IP65. Bi-Level Control with Adjustable Hold Time, Dim Level and Standby Time. Installs via standard 1/2in KO	843654134147	BKG-51



\* For factory installation of accessory, add suffix to fixture part number (see ordering examples and instructions on last page of spec sheet).

#### CORD SETS

**Factory-Installable OR Field-Installable** (field-installable purchased separately)

✓	SUFFIX*	CATALOG NUMBER	DESCRIPTION	UPC	EASY CODE
	/515P6	KT-CS-515P-6-18/3	Cord set for high bay; 125V NEMA 5-15P; straight blade plug; 6' SJTOW cable; 18/3 wire	843654140124	UKH-26
	/L515P6	KT-CS-L515P-6-16/3	Cord set for high bays; 250V NEMA L5-15P; twist lock plug; 6' SJTOW cable; 16/3 wire	843654140186	POC-82

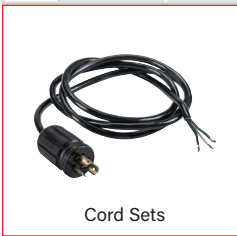

\* For factory installation of accessory, add suffix to fixture part number (see ordering examples and instructions on last page of spec sheet).  
**Note:** For cord sets not listed here, please contact your Keystone sales rep.

#### EMERGENCY BACKUP

**Factory-Installable OR Field-Installable** (field-installable purchased separately)

✓	SUFFIX*	CATALOG NUMBER	DESCRIPTION	UPC	EASY CODE
	/EM12	KT-EMRG-LED-12C-1200	LED Emergency Back-Up, 12W Constant Wattage Design. Approx 1200 Lumens. 120-277V Input. Remote Compact Battery Pack. CEC T20 Compliant.	843654103112	OJQ-32
	-	KT-EMRG-LED2-TS-IP65	IP65 Rated Wet Location Test Switch for 5W and 12W CEC Compliant LED Emergency Packs	843654130019	MDB-29

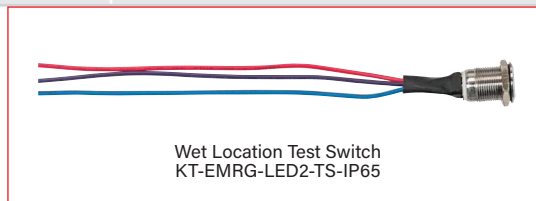

\* For factory installation of accessory, add suffix to fixture part number (see ordering examples and instructions on last page of spec sheet).  
\* Factory installation of emergency backup units will automatically include any relevant mounting bracket.

(Accessories continued on next page)



# KT-WPLED80-M1-8CSB-VDIM-W

## TRADITIONAL NON-CUTOFF LED WALL PACK

**ACCESSORIES** (continued)

**SURGE PROTECTORS**

**Factory-Installable OR Field-Installable** (field-installable purchased separately)

✓	SUFFIX*	CATALOG NUMBER	DESCRIPTION	UPC	EASY CODE
	/10KV	KTSP-10KV-C	External Surge Protector, compact design. Parallel Wiring, 120-277V Input, Max Peak Protection (10KV, 10KA)	843654129204	BUU-26



*\* For factory installation of accessory, add suffix to fixture part number (see ordering examples and instructions on last page of spec sheet).*



# KT-WPLED80-M1-8CSB-VDIM-W

## TRADITIONAL NON-CUTOFF LED WALL PACK

### ORDERING INFORMATION

CATALOG NUMBER	PACK QTY.	UPC	EASY CODE	DLC PRODUCT ID
KT-WPLED80-M1-8CSB-VDIM-W	1	843654133799	VTP-56	P7RBDFAF

### CATALOG NUMBER BREAKDOWN

# KT-WPLED80-M1-8CSB-VDIM-W

1	2	3	4	5	6	7	8	9	10	11	12
<b>1 Keystone Technologies</b>	<b>2 Fixture Type</b>	<b>3 LED Lamp</b>	<b>4 Wattage</b>	<b>5 Size</b>	<b>6 Style</b>	<b>7 CRI</b>	<b>8 Color Select</b>	<b>9 Color Select Designation</b>	<b>10 Dimming</b>	<b>11 Housing Colors</b>	<b>12 Accessories</b> (see below for details)
	WP Wallpack			M Medium	1 Non-Cutoff	8 >80		B 3000/4000/5000K	VDIM 0-10V		
							<b>11 Housing Color</b>				
							W White				

### ORDERING EXAMPLES

FIXTURE WITH MULTIPLE FACTORY-INSTALLED ACCESSORIES\*

KT-WPLED80-M1-8CSB-VDIM-W /MW3/515P6/EM12

FIXTURE WITH SINGLE FACTORY-INSTALLED ACCESSORY

KT-WPLED80-M1-8CSB-VDIM-W /MW3

FIXTURE WITH NO FACTORY-INSTALLED ACCESSORIES

KT-WPLED80-M1-8CSB-VDIM-W

\* When ordering more than one factory-installed accessory, use multiple suffixes as shown in the ordering examples above.  
 Note: All accessories can also be ordered separately for field installation using just their regular Catalog Number, UPC, or Easy Code.

KEYSTONE FIXTURE	
CATALOG NUMBER	
KT-WPLED80-M1-8CSB-VDIM-W	

SENSORS	
SUFFIX	CATALOG NUMBER
✓ /MW3	KTS-MW3-UV-KO-K1

CORD SETS	
SUFFIX	CATALOG NUMBER
✓ /515P6	KT-CS-515P-6-18/3

EMERGENCY BACKUP	
SUFFIX	CATALOG NUMBER
✓ /EM12	KT-EMRG-LED-12C-1200