

SINCE 1945
KEYSTONE
LIGHT MADE EASY®

XFIT

OUTDOOR FIXTURES



XFIT Outdoor Fixtures

Keystone's line of highly efficient LED outdoor lighting solutions.

Keystone has a solution for your entire building, inside and out. We're expanding our popular line of XFit fixtures and heading outdoors to meet your lighting needs for building exteriors, parking lots, pathways and general outdoor areas. Look for our Color Select and Power Select technology on many of these new fixtures, allowing you to field select from multiple color temperatures or lumen outputs with a simple switch.

Count on Keystone to bring you well-designed, versatile products that allow for dramatic SKU/stocking reductions and help contractors save time with easy installation, while providing customers with dramatic energy savings.

High Power Floodlights with OpticSwap	4	Full Cutoff Wall Packs	32
Floodlights	8	Adjustable Wall Packs	36
Sports Lights	12	Small Low Profile Wall Packs ..	40
Bullet Floodlights	16	Canopy Light Fixtures	44
DMX Linear Wall Washers.....	20	Area Lights with OpticSwap ...	48
Traditional-Slim Wall Packs.....	24	Dusk-to-Dawn Fixtures	56
Traditional Wall Packs	28	Product Specs	60



XFIT

High Power Floodlights with optic^{swap}

A powerful, adjustable light ideal for larger spaces



OPTIC SWAP LENS CHANGE

Tool-free technology allows users to change optics on site, so coverage can be changed on the fly



CUSTOMIZABLE FEATURES

Dusk-to-dawn photocell, Power & Color Select technology offer flexible power outputs, CCT, available on/off daylight sensing

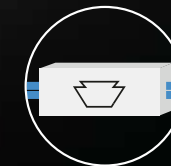

BUILT-IN 120-277V OR 277-480V KEYSTONE LED DRIVER

Provides 0-10V dimming & ample surge protection for increased versatility and reliability



EVERYTHING IN THE BOX

Includes fixture, 3 optic lenses, multiple mounting options, photocell, and shorting cap—one fixture can handle an entire job



Two mounting options included with every fixture



RoHS Compliant



10 YEAR LIMITED WARRANTY

High Power Floodlights with optic swap

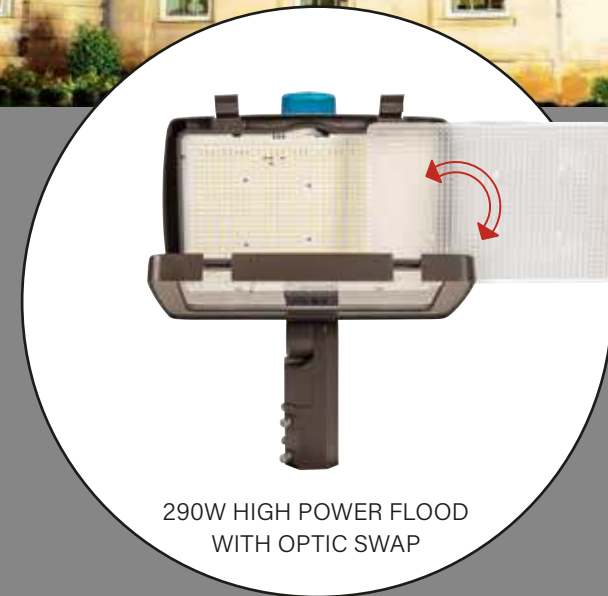

Available in 277-480V high-voltage options

290W HIGH POWER FLOOD WITH OPTIC SWAP

FEATURES AND BENEFITS

- Includes 3 optic lenses: NEMA 7x6 installed, NEMA 6x6 and 5x5 included
- Glare shield and lens kits for multiple beam angles available
- Protected from the elements with IP65 rating
- Die-cast aluminum housing
- High-voltage (480V) options available

Includes Keystone NEMA ANSI C136.10-2010 3-pin twist-lock photocell



290W Ground Mount

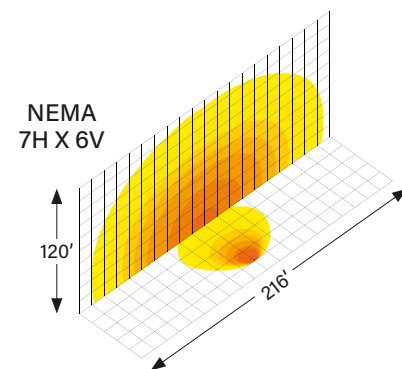
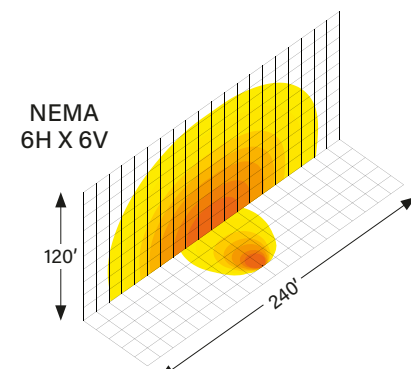
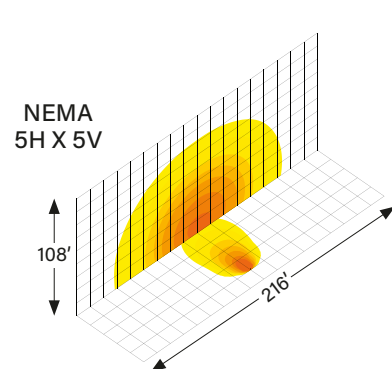

[Return to Table of Contents](#)



SHOWN IN WHITE WITH SLIPFITTER MOUNT



GLARE SHIELD



POWER & COLOR SELECT SWITCHES





XFIT

Floodlight Fixtures

Powerful, efficient LED lighting with incredible versatility



POWER AND COLOR SELECT TECHNOLOGY

Reduce SKUs, increase flexibility with field-adjustable power output and color temperature



BUILT-IN DUSK-TO-DAWN PHOTOCELL

With activation, automatically turns on/off when daylight is available for increased energy savings

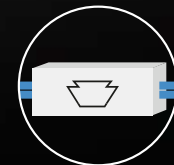

BUILT-IN 120-277V KEYSTONE LED DRIVER

Provides 0-10V dimming & ample surge protection for increased versatility and reliability



CONSOLIDATE SKUs WITH INCLUDED INTERCHANGEABLE MOUNTING OPTIONS

Yoke & knuckle mount included for 15W, 35W, & 60W; slipfitter & trunnion mount included for 75W & 100W ensures universal fit



Two mounting options
included with every fixture



RoHS
Compliant



50,000 HOUR
LIFETIME



10 YEAR
LIMITED WARRANTY

Floodlight Fixtures

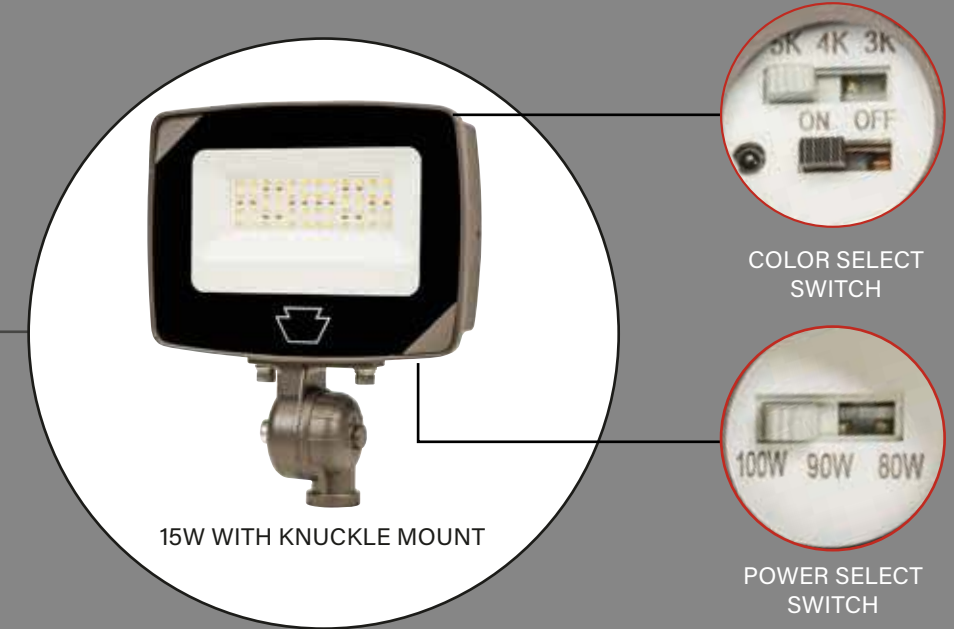

15W WITH KNUCKLE MOUNT

FEATURES AND BENEFITS

- Easy installation with included mounts
- Protected from the elements with IP65 rating
- Die-cast aluminum housing

15W Floodlight:
Ground Mount at 6" above
horizontal; 8' from wall

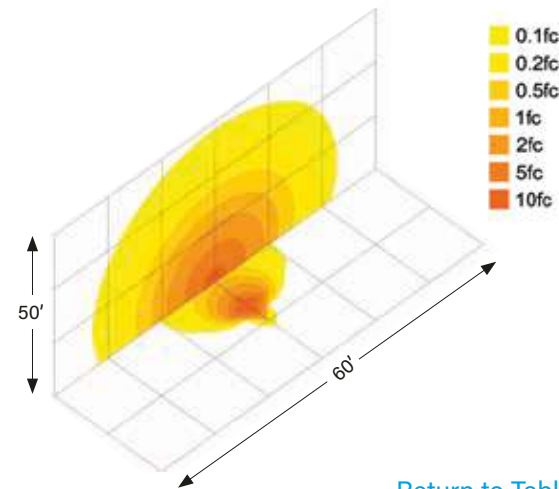

[Return to Table of Contents](#)



PROTECTIVE TRANSLUCENT
PLUG PROVIDES EASY
ACCESS TO PHOTOCELL



SHOWN IN BRONZE
WITH YOKE MOUNT



SHOWN IN WHITE
WITH KNUCKLE MOUNT



15W CONTRACTOR PRIME
ALSO AVAILABLE IN
DEDICATED-ONLY OPTIONS

XFIT

Sports Light

A powerful, easy-to-install sports light with remote driver capability



REMOTE MOUNT DRIVER

Detachable driver box simplifies installation and maintenance; can be mounted remotely up to 164 feet (50m) from fixture



PRECISION OPTICS

Lenses ensure uniform, proper lighting; available in multiple beam angle options

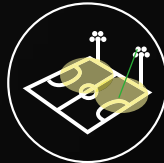

COMPLIMENTARY LAYOUTS

Our free service recommends correct number of fixtures and their exact placement for aiming guidelines

IP65
RATED



RoHS
Compliant

10 YEAR
LIMITED WARRANTY

Sports Light



FEATURES AND BENEFITS

- Heavy-duty die-cast aluminum housing for a durable and modern aesthetic
- Precision-crafted optics ensure uniform lighting
- Designed for install as a single assembly or with remote driver box up to 164' (50m) away, allowing for installation flexibility

750W, 65' Pole Mount
30° Beam

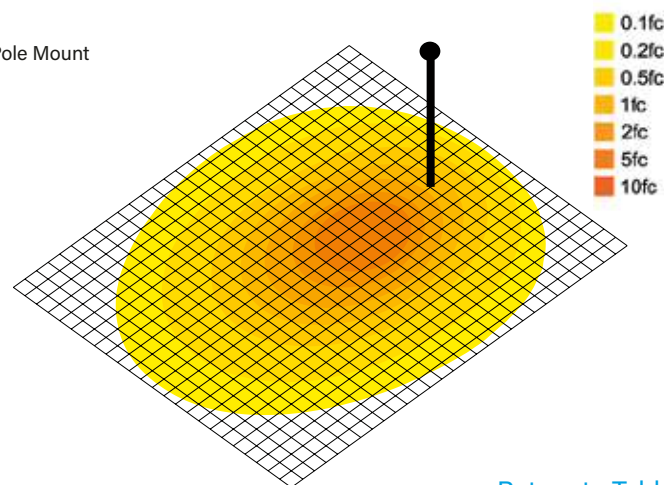

MULTIPLE LENS OPTIONS:
30° STANDARD; 20° & 40° OPTIONAL

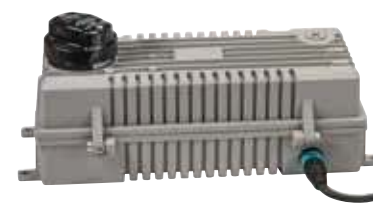

REMOVABLE REMOTE DRIVER BOX
FOR INSTALLATION FLEXIBILITY



SHOWN WITH INCLUDED
GLARE SHIELD



XFIT | Bullet Floodlights

Unique and versatile LED bullet floodlights with a sleek, modern design



POWER SELECT TECHNOLOGY

Three (3) different power outputs help reduce SKUs and increase flexibility

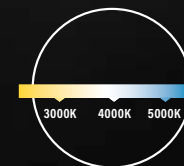

COLOR SELECT TECHNOLOGY

Adjustable: 3000K / 4000K / 5000K



BUILT-IN DUSK-TO-DAWN PHOTOCELL

With activation, automatically turns on/off when daylight is available for increased energy savings

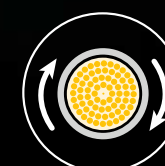

EASILY ADJUSTABLE OPTICS

Additional optic lens, included in the box, can be installed using convenient twist on/off lens cap



Additional optic lens and accessories included



IP65 RATED

10 YEAR LIMITED WARRANTY

Bullet Floodlights



25W WITH PRE-INSTALLED KNUCKLE MOUNT



FEATURES AND BENEFITS

- Built-in glare shield and lens to light your subjects consistently
- Two optic lenses included in one box:
 - NEMA 4H x 4V
 - NEMA 3H x 3V
- Protected from the elements with IP65 rating
- Fits easily into pre-installed knuckle mount

COLOR SELECT SWITCH PHOTOCELL ON/OFF SWITCH

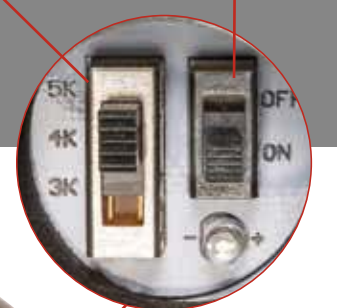

25W Bullet Floodlight:
Aimed 45° above horizontal
10' from building
6" above ground; 4x4 optics

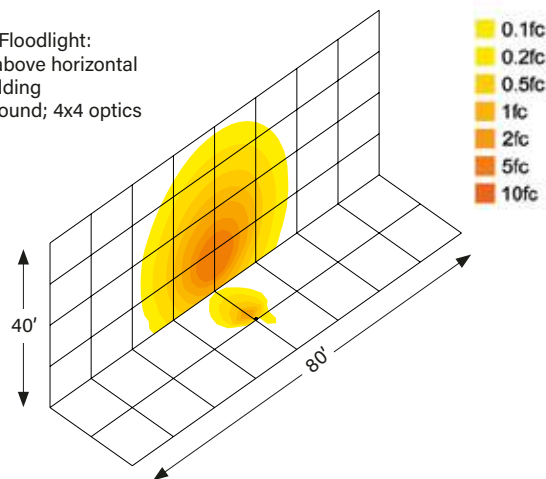

25W Bullet Floodlights:
Quantity: 3
Aimed 60° above horizontal
15' from pole
6" above ground; 3x3 optics

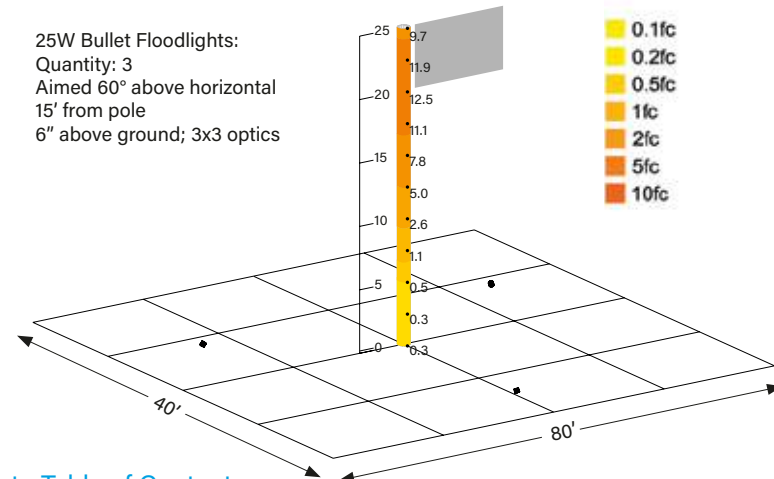

SHOWN IN WHITE

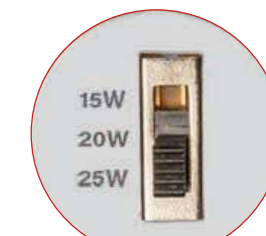

POWER SELECT SWITCH





DMX Linear Wall Washer

Full RGBW capability that installs and programs in minutes



SmartLoop controller used for enabling connected light bars



SMART LOOP WIRELESS CONTROL

RGBW color control, sequencing, and scheduling commissions and edits in minutes with reliable Bluetooth mesh connectivity



DMX AND RDM COMPATIBLE

Allows for compatibility with all industry-proven full-scale DMX512-based control solutions

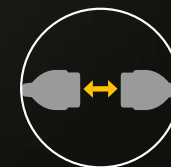

SIMPLE INSTALLATION

Just plug and play; daisy-chain fixtures end to end, either with or without optional linking cable accessories



DMX Linear Wall Washer

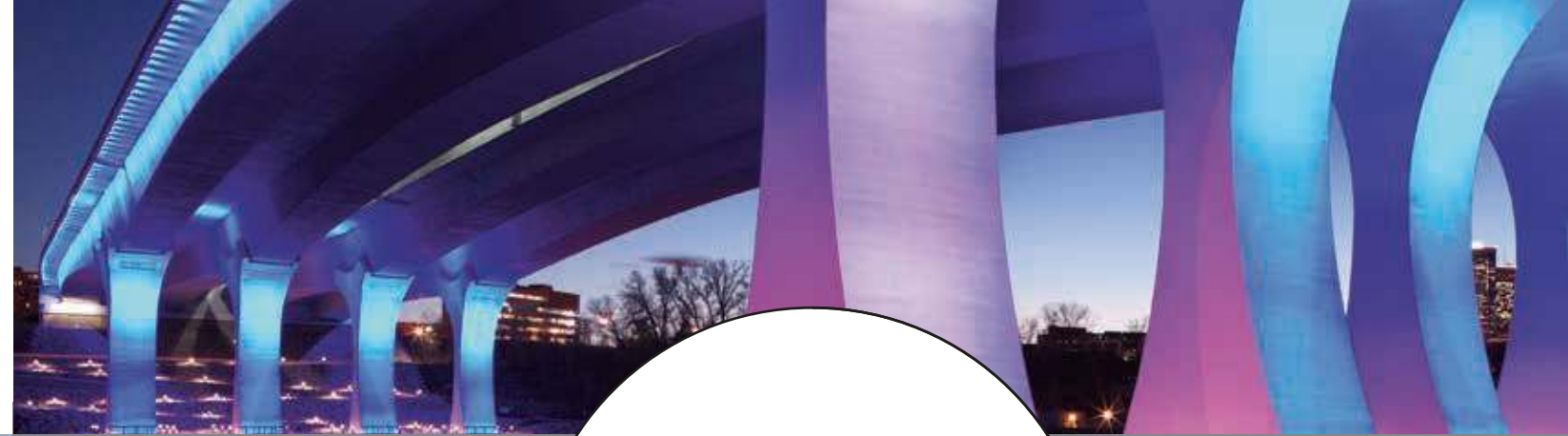

FEATURES AND BENEFITS

- Control flexibility with SmartLoop, using Keystone SmartLoop Controller, or with DMX with the DMX connection cord
- SmartLoop app provides simple DIY programming that can easily be given to building owner/facility management
- Linkable with up to 40 fixtures in one series
- Rotatable hinges allow for easy positioning
- Medium distribution pattern



12W 2' Wall Washers

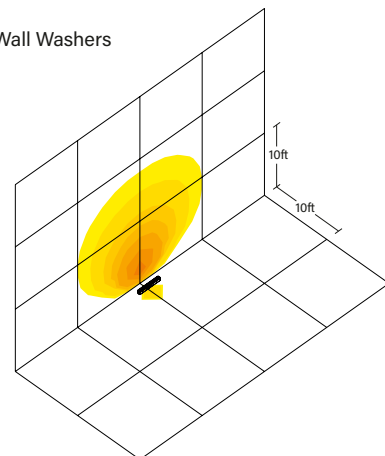

24W 4' Wall Washers

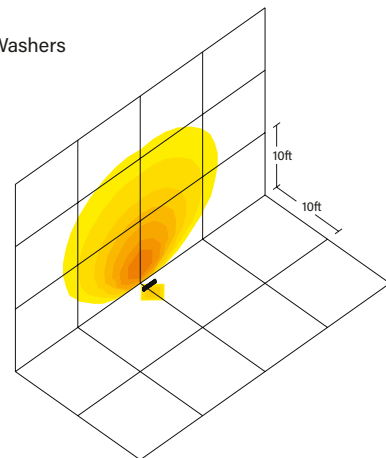

[Return to Table of Contents](#)



MOUNTING BRACKETS ALLOW EASE OF INSTALL



LINKING CORD SET FOR DMX CONTROL



SMART LOOP WIRELESS CONTROLLER AVAILABLE WITH NEMA 5-15P OR 3-WIRE INPUT



COMMISSION AND PROGRAM IN MINUTES WITH SMART LOOP APP

XFIT | Traditional-Slim Wall Pack

Selectable technology; slim, low-profile design



SLIM DESIGN

Slim, low-profile design that matches footprint and distribution of legacy HID wall packs. Optimized for one-for-one replacements



SIMPLE MAINTENANCE

Easily accessible compartment makes Keystone 0-10V dimming LED driver simple to service



POWER AND COLOR SELECT TECHNOLOGY

Reduce SKUs, increase flexibility with field-adjustable power output and color temperature



BUILT-IN DUSK-TO-DAWN PHOTOCELL

With activation, automatically turns on/off when daylight is available for increased energy savings



10 YEAR LIMITED WARRANTY

Traditional-Slim Wall Packs

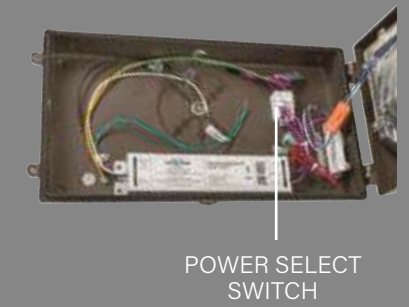
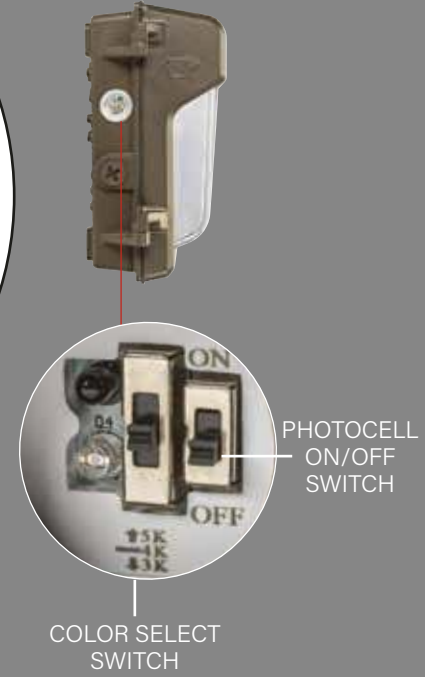
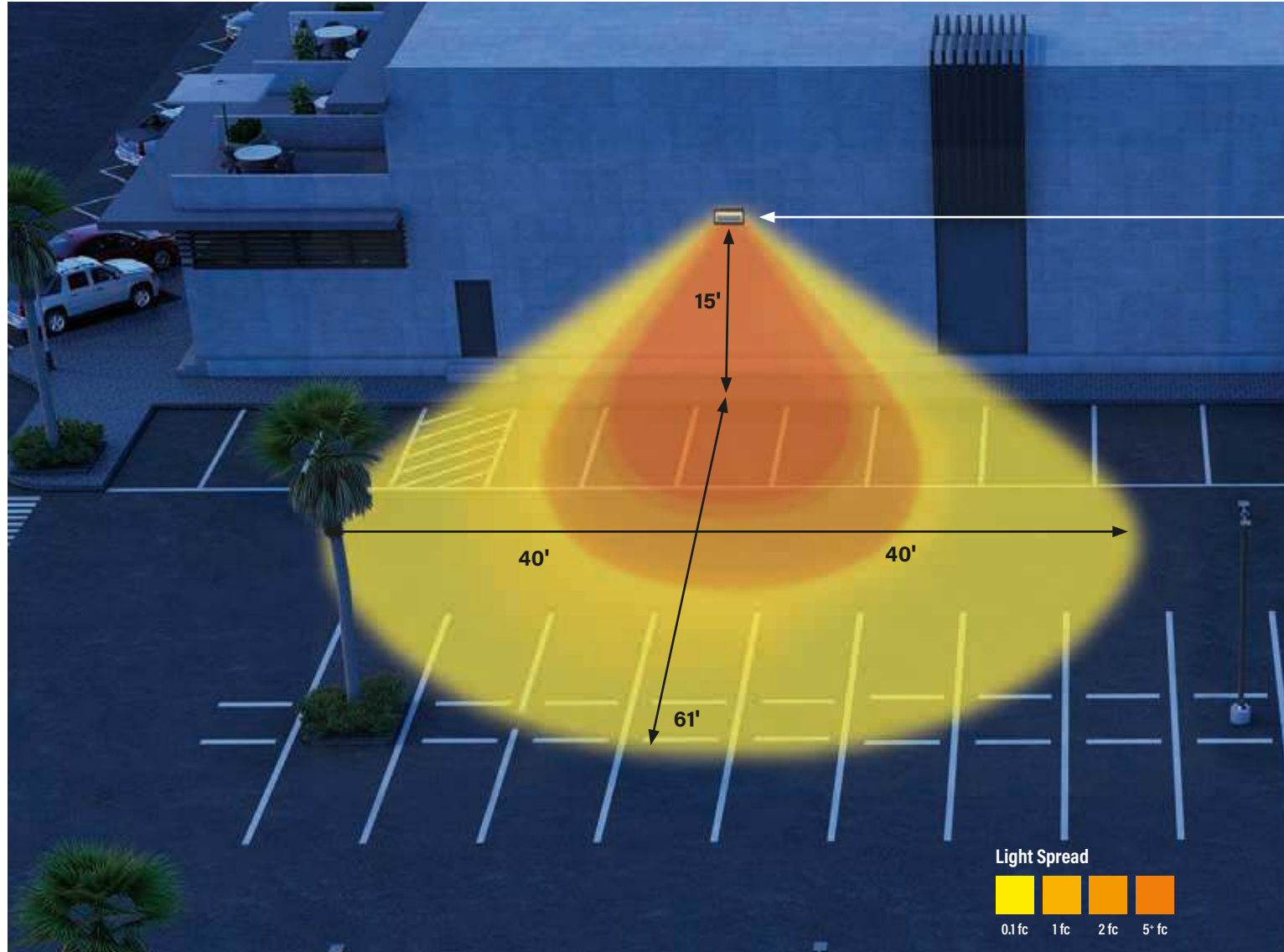

FEATURES AND BENEFITS

- Slim, low-profile design matches footprint of existing legacy fixture, so no need to repaint to fix outline
- UL Certified for wet locations; IP65 rated
- Heavy-duty die-cast aluminum housing
- Covers footprint of mid-size HID wall packs
- Built-in dusk-to-dawn photocell behind translucent 3/4" threaded plug with anti-yellowing agent

35W Slim WP: Building exterior mounted at 15'

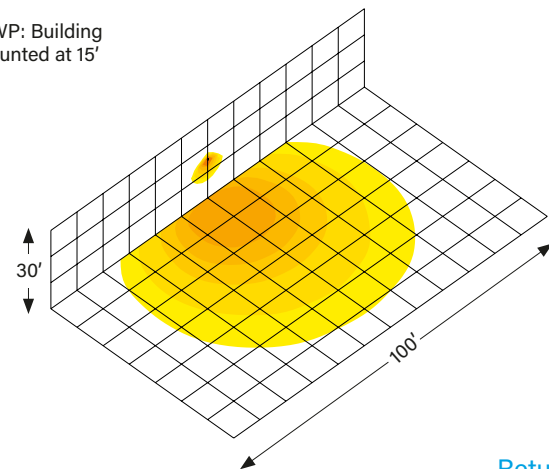

[Return to Table of Contents](#)

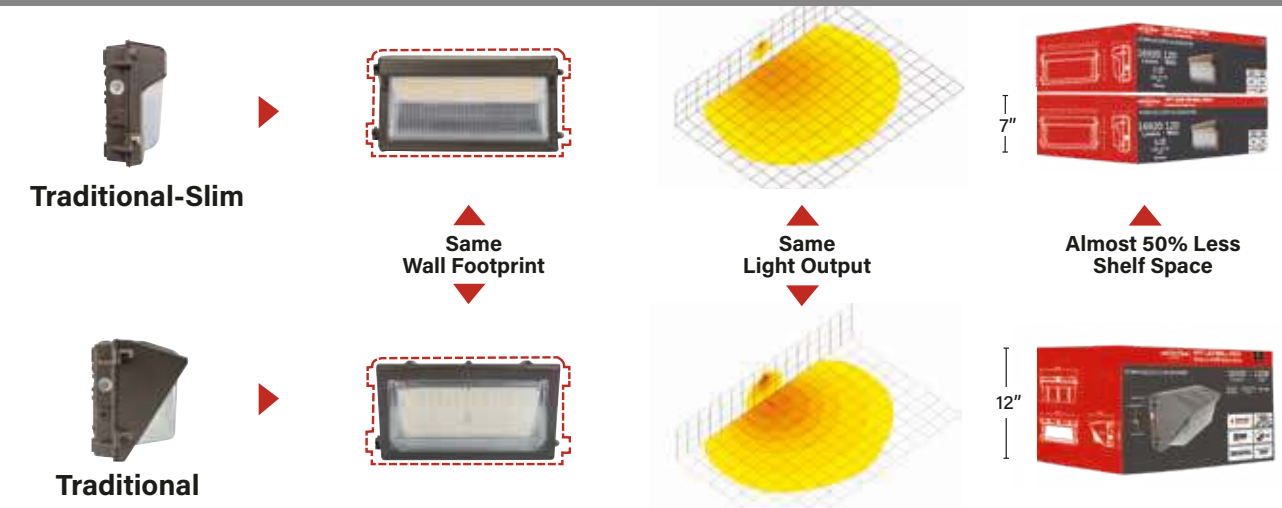

XFIT | Traditional Wall Pack

Match appearance of legacy HID fixtures while covering same footprint

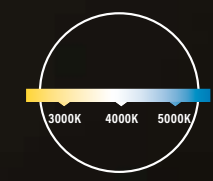

COLOR SELECT TECHNOLOGY
Adjustable: 3000K / 4000K / 5000K



BUILT-IN DUSK-TO-DAWN PHOTOCELL
With activation, automatically turns on/off when daylight is available for increased energy savings

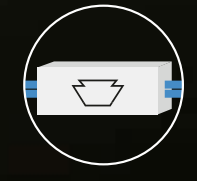

BUILT-IN 120-277V KEYSTONE LED DRIVER
Provides 0-10V dimming & ample surge protection for increased versatility and reliability



EASY INSTALLATION
Five (5) KO access points (4 sides and 1 back) and captive screws included



Traditional Wall Packs

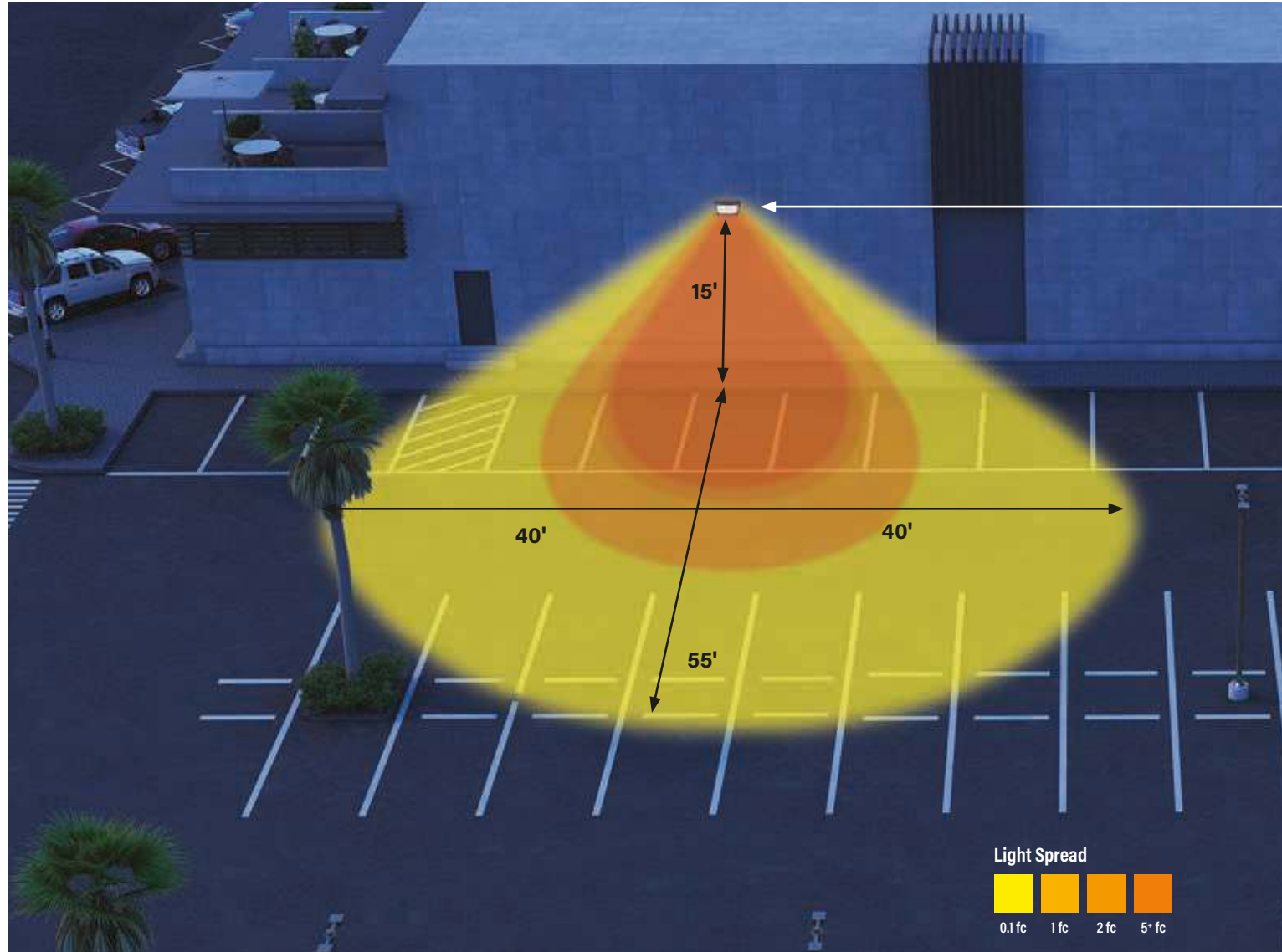

35W TRADITIONAL WALL PACK FEATURING BOROSILICATE GLASS LENS

FEATURES AND BENEFITS

- Photocell with 0-10V dimming
- Provides uniform light distribution with advanced optical lens technology
- Fits existing legacy product footprint (14" & 17")
- Designed with two dip switches (for photocell and color temperature adjustment) protected by a translucent plug
- Borosilicate glass lens is high-impact resistant and prevents discoloration over time

35W Traditional WP:
Building exterior
mounted at 15'

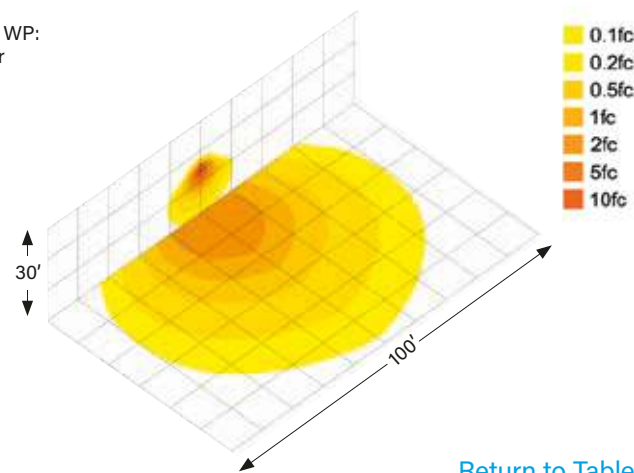

[Return to Table of Contents](#)



SIDE OPENING FOR EASY ACCESS



SHOWN IN WHITE



SHOWN IN BRONZE

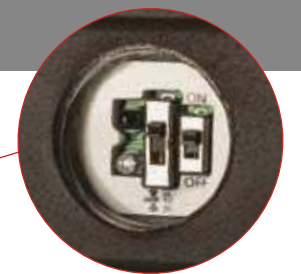

PROTECTIVE TRANSLUCENT SWITCH PLUG TO ACCESS PHOTOCELL AND COLOR TEMPERATURE DIP SWITCHES

XFIT | Full Cutoff Wall Packs

Optimize light distribution and improve appearance of building exteriors



CONTEMPORARY APPEARANCE

Features architectural full cutoff design

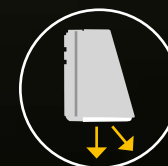

OPTIMIZE LIGHT DISTRIBUTION

Light the same area with fewer fixtures

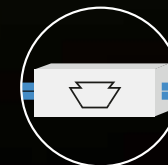

BUILT-IN 120-277V KEYSTONE LED DRIVER

Provides 0-10V dimming & ample surge protection for increased versatility and reliability



50,000 HOUR LIFETIME

IP65 RATED

10 YEAR LIMITED WARRANTY

Full Cutoff Wall Packs

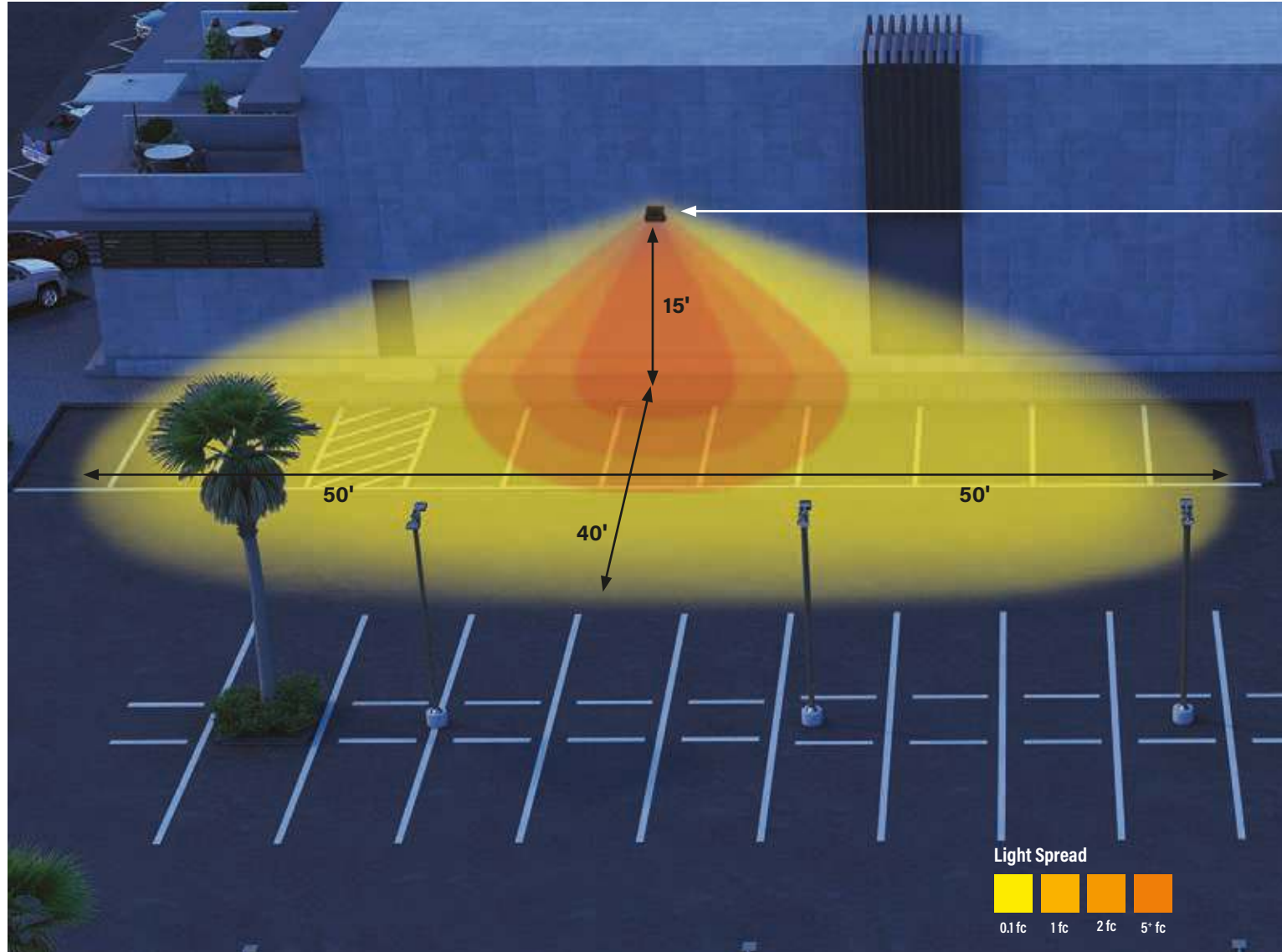

FEATURES AND BENEFITS

- Eliminates undesirable sky glow and glare with dark-sky friendly performance
- Covers the existing footprint of mid-size legacy HID fixtures with an updated design, while hiding any unsightly marks and fading
- Increases control and energy efficiency with photocell accessory (available separately)
- Provides wide light distribution with advanced optical lens technology, ideal for increased fixture spacing and uniformity

40W Full Cutoff WP:
Building exterior mounted at 15'

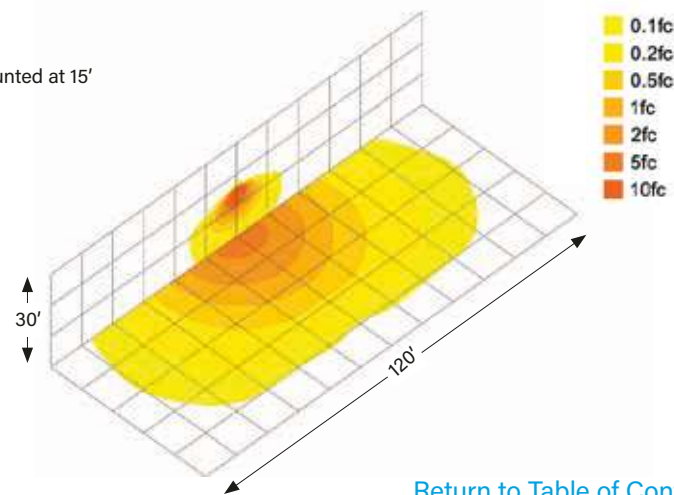

[Return to Table of Contents](#)



SIDE OPENING FOR EASY ACCESS



HEAVY-DUTY DIE-CAST ALUMINUM HOUSING
FEATURES MODERN AESTHETICS

XFIT | Adjustable Wall Packs

A rugged light with an adjustable axis that directs illumination



FIELD-ADJUSTABLE FLEXIBILITY

Positions along a 0°-90° axis to illuminate areas missed by traditional forward throw wall packs



POWER SELECT TECHNOLOGY

Three (3) different power outputs help reduce SKUs and increase flexibility



COLOR SELECT TECHNOLOGY

Adjustable: 3000K / 4000K / 5000K

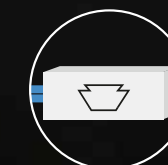

BUILT-IN 120-277V KEYSTONE LED DRIVER

Provides 0-10V dimming & ample surge protection for increased versatility and reliability



IP65 RATED

10 YEAR LIMITED WARRANTY

Adjustable Wall Packs

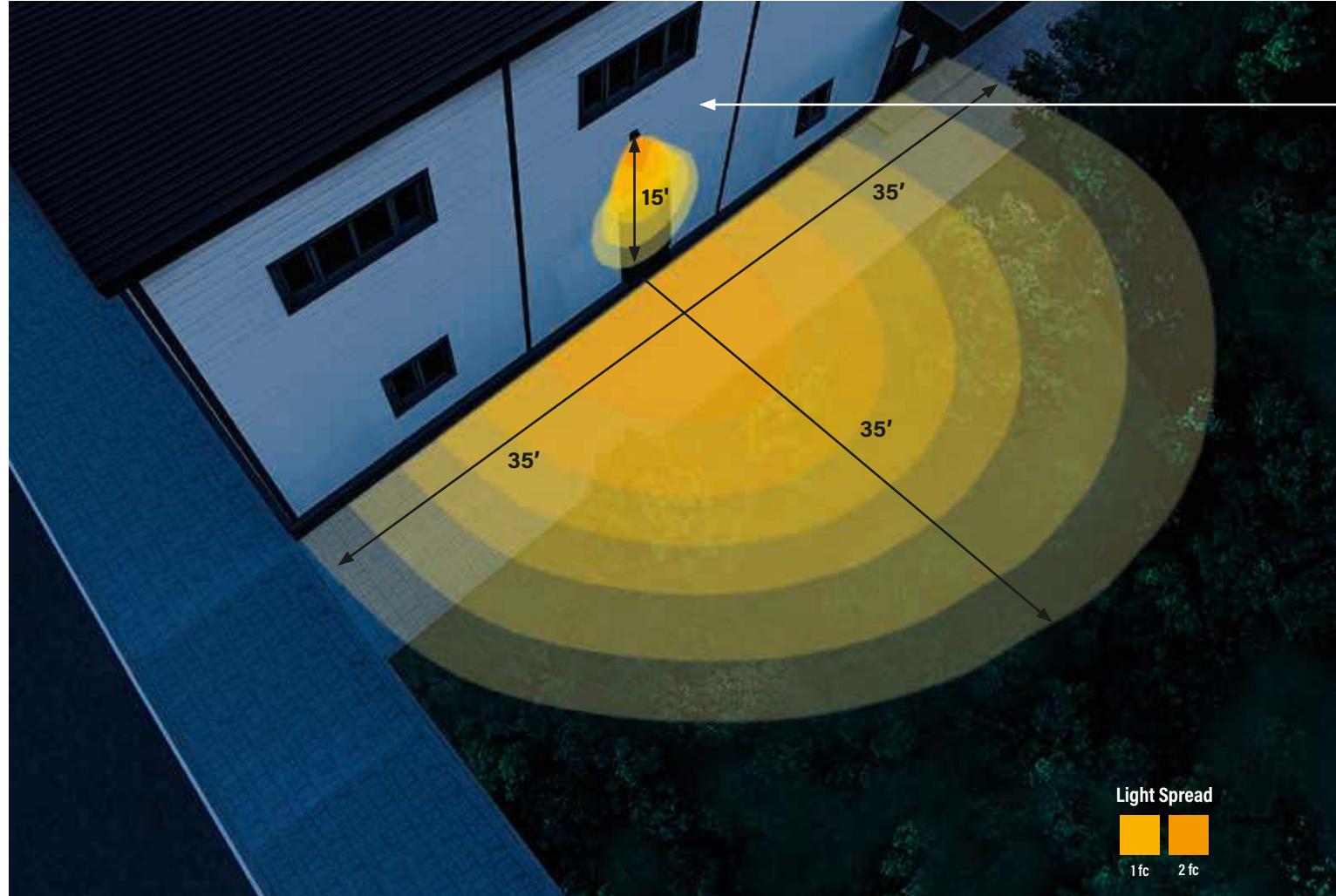

35W Adjustable Wall Pack:
Building mounted 15'

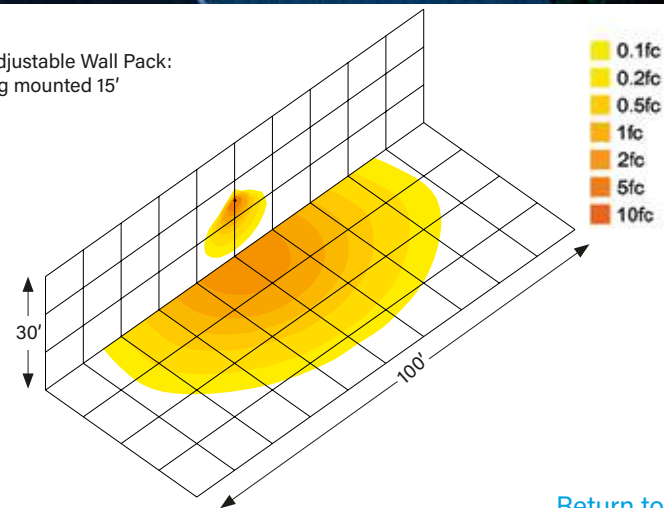

[Return to Table of Contents](#)



35W ADJUSTABLE
WALL PACK

FEATURES AND BENEFITS

- Built-in dusk-to-dawn photocell, when activated, automatically turns on/off when daylight is available, helping increase energy savings
- Heavy-duty die-cast aluminum housing for enhanced thermal performance and reliability
- Protected from the elements with IP65 rating

COLOR SELECT
SWITCH

PHOTOCELL ON/OFF
SWITCH

POWER SELECT
SWITCH

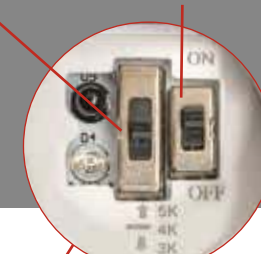

0° ANGLE



45° ANGLE



90° ANGLE



KEYSTONE DRIVER PRE-INSTALLED

XFIT

Small Low Profile Wall Packs

Flexible mounting
virtually anywhere
with a compact design

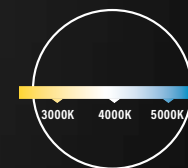

COLOR SELECT TECHNOLOGY (ON SELECT MODELS)

Adjustable: 3000K / 4000K / 5000K



BUILT-IN DUSK-TO-DAWN PHOTOCELL

With activation, automatically turns on/off when daylight is available for increased energy savings



INTEGRATED EMERGENCY OPTIONS AVAILABLE

Available with fully integrated, code-approved EMRG components: built-in LED emergency pack and test button

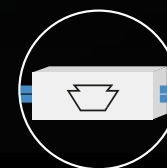

BUILT-IN 120-277V KEYSTONE LED DRIVER

Provides 0-10V dimming & ample surge protection for increased versatility and reliability



50,000 HOUR
LIFETIME

IP65
RATED



10 YEAR
LIMITED WARRANTY

Small Low Profile Wall Packs

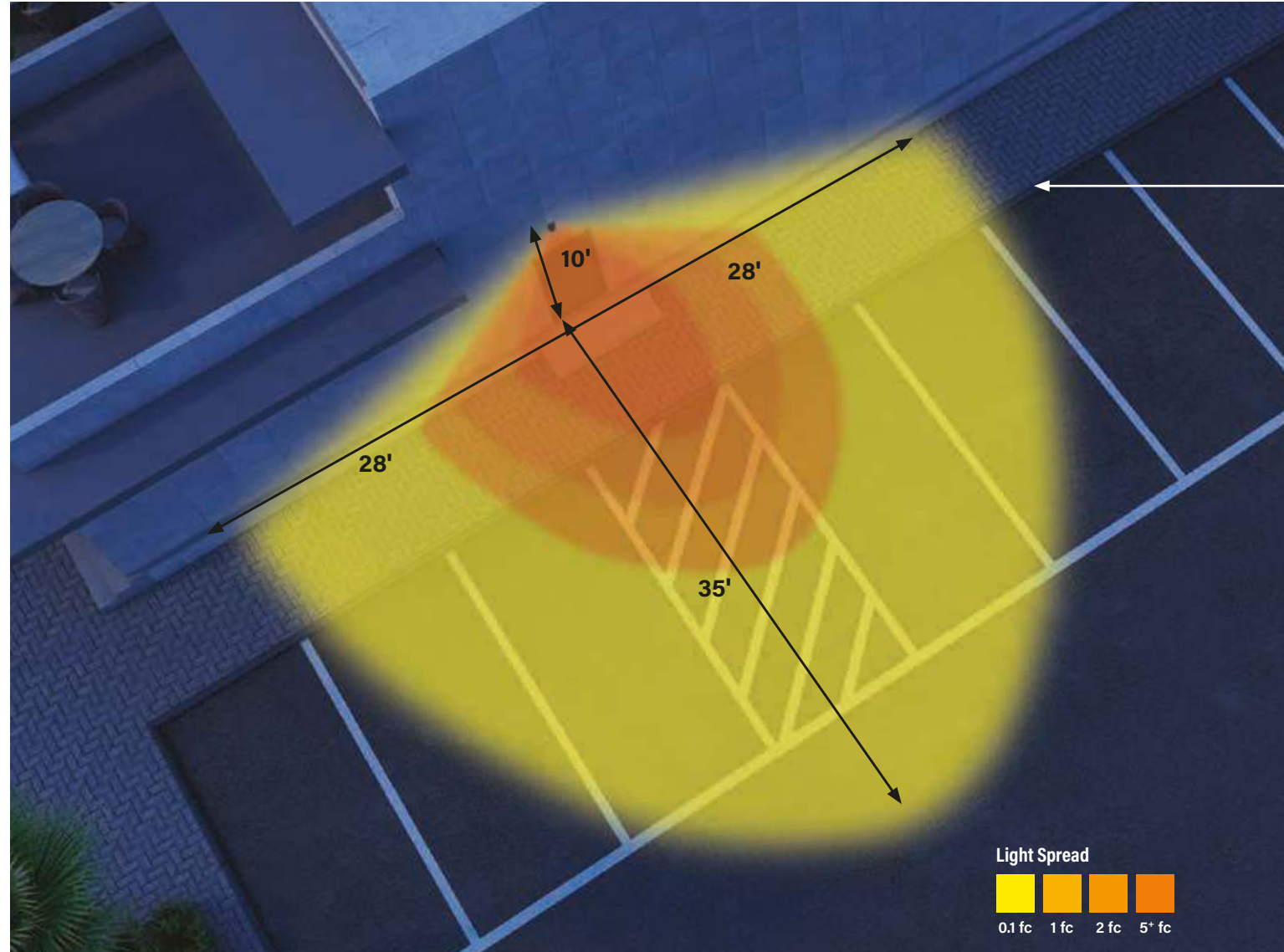

20W SMALL LOW PROFILE WALL PACK

FEATURES AND BENEFITS

- Meets general safety and security illumination needs with a uniform vertical and horizontal light distribution pattern
- Ensures reliable operation with a Keystone LED dimming driver
- Provides ADA compliance with low-profile housing (less than 4" deep)
- Reduces glare at low mounting height applications with advanced poly carb lens technology
- Designed with two dip switches (protected by a translucent plug) to disable the photocell and adjust color temperature as needed

20W Small Wall Pack: Building exterior mounted at 10'

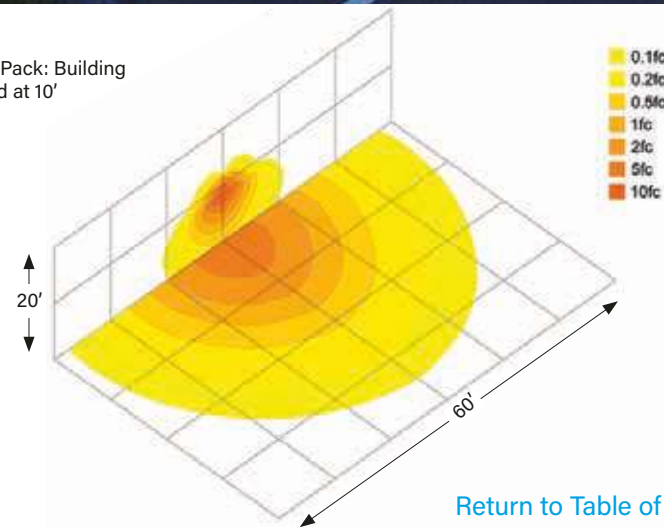

[Return to Table of Contents](#)



EMERGENCY VERSION MATCHES AESTHETIC TO COMPLETE ENTIRE SPACE



SHOWN IN WHITE



SHOWN IN BLACK



PROTECTIVE TRANSLUCENT SWITCH PLUG TO ACCESS PHOTOCELL AND COLOR TEMPERATURE DIP SWITCHES

XFIT | Canopy Fixtures

Versatility and durability for covered outdoor applications



POWER AND COLOR SELECT TECHNOLOGY

Reduce SKUs, increase flexibility with field-adjustable power output and color temperature



DUSK-TO-DAWN PHOTOCELL INCLUDED

Automatically turns on/off when daylight is available for increased energy savings



SIMPLE INSTALLATION

Innovative fixture bracket allows for hands-free wiring and installation



SMART LOOP COMPATIBLE

Works with screw-in Keystone SmartLoop RF controllers for easy smart fixture operation



IP65
RATED

10 YEAR
LIMITED WARRANTY

Canopy Fixtures

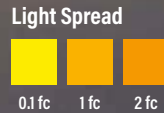
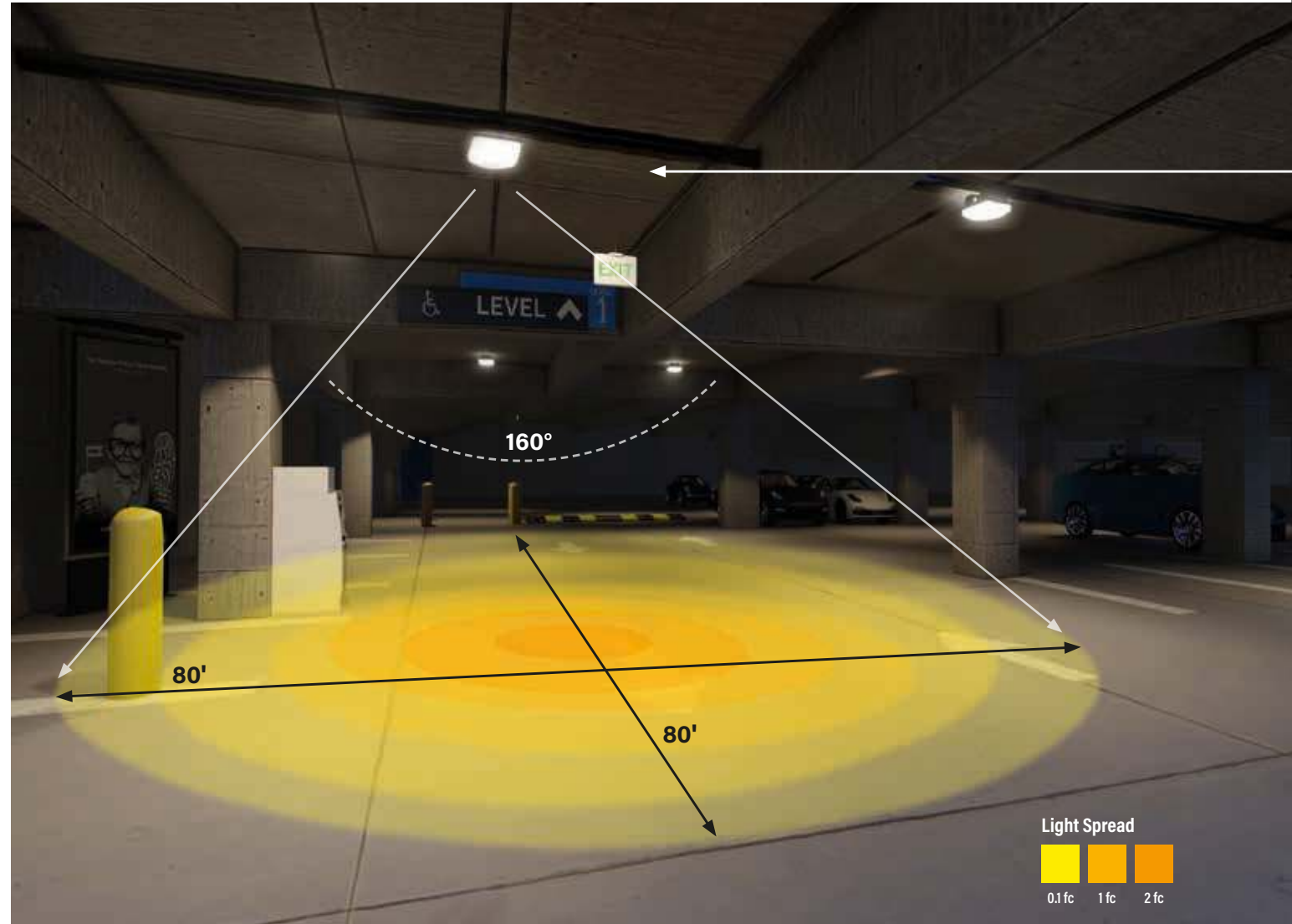

COLOR SELECT SWITCH



40W CANOPY FIXTURE



POWER SELECT SWITCH

FEATURES AND BENEFITS

- Heavy-duty die-cast aluminum housing with a modern aesthetic
- Suitable for standard junction box mounting or 3/4" NPT pendant mounting
- Impact-resistant polycarbonate diffuser with 160° parking garage distribution
- Powered by Keystone LED 0-10V dimming driver
- Protected from the elements with IP65 rating

OPTIONAL 110° DISTRIBUTION DIFFUSER AVAILABLE

40W 160° distribution canopy at 12.5' mounting light

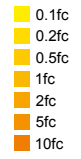
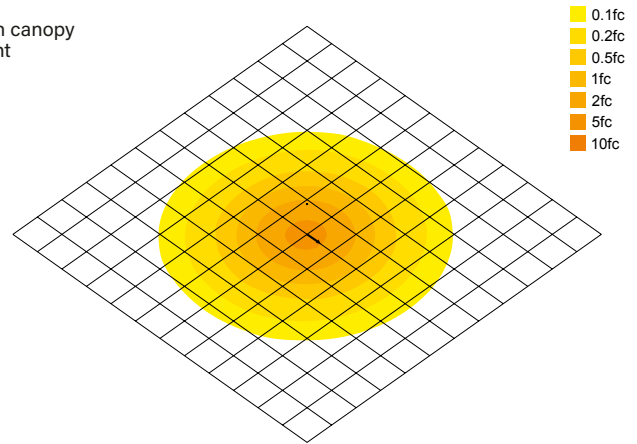

SHOWN IN WHITE



BRACKET ALLOWS FOR HANDS-FREE WIRING AND INSTALLATION



SMART PORT SCREW-IN SENSOR CAPABILITY





Area Lights with optic_{swap}

One versatile fixture that does it all

XFit Area Lights with OpticSwap simplify installation, contracting, and distribution. With OpticSwap, lens optics can be switched out without tools, simply by undoing two clasps. And as part of Keystone's all-in-the-box kitted stocking special, distributors can make area lights a stockable item and contractors don't need to rely on custom orders.

With multiple lenses and Power and Color Select technology, XFit Area Lights with Optic Swap can meet the demands of numerous jobs.



OPTIC SWAP LENS SWITCHABILITY

Field-install optic lenses in seconds while keeping an IP65 rating, no tools required



POWER SELECT TECHNOLOGY (on select models)

Three (3) different power outputs help reduce SKUs and increase flexibility

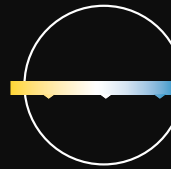

COLOR SELECT TECHNOLOGY (on select models)

Three (3) different color temperatures provide the right light for your project

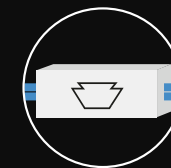

BUILT-IN 120-277V KEYSTONE LED DRIVER WITH HIGH-VOLTAGE OPTIONS

All area lights equipped with 0-10V dimming driver and ample surge protection



SMART PORT COMPATIBLE

Works with contractor-friendly screw-in motion sensors easily field-installed with no wiring



Area Lights with optic_{swap}

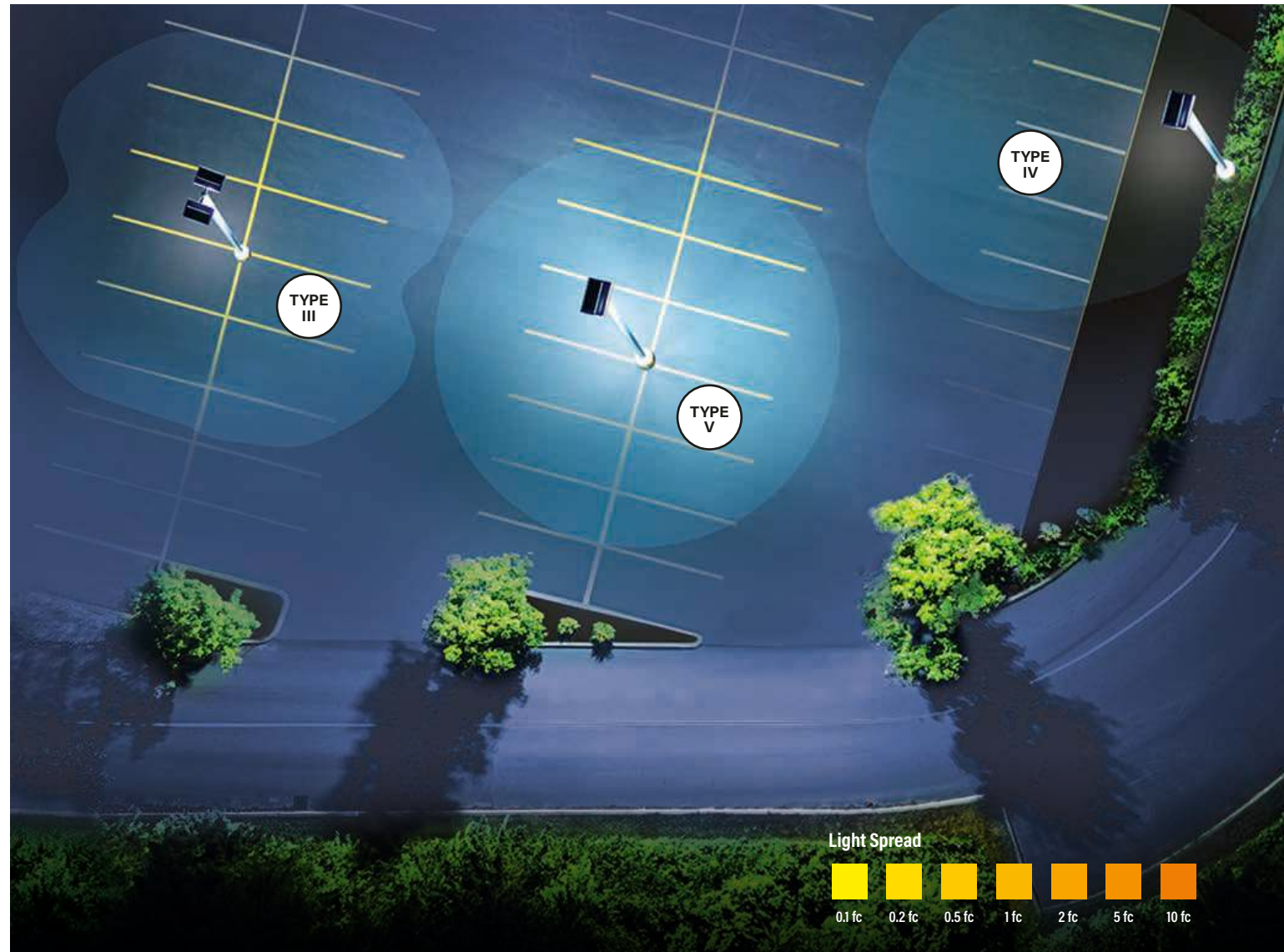
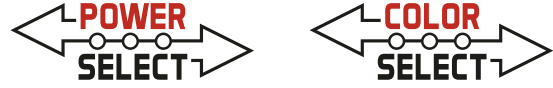

290W AREA LIGHT

optic_{swap}

- Easy access—simply undo 2 clasps
- No tools, no screws needed
- Change in seconds
- Maintains IP65 rating

FEATURES AND BENEFITS:

- Keystone LED dimming driver ensures reliable operation
- Designed with two dip switches (protected by a translucent plug) to disable photocell and adjust color temperature as needed
- Compact low-profile design delivers high-performance illumination and improves application site aesthetics
- Heavy-duty die-cast aluminum housing with ample heat sinking for enhanced thermal performance
- Dark Sky friendly performance, eliminates undesirable sky glow



POWER SELECT SWITCH

COLOR SELECT SWITCH

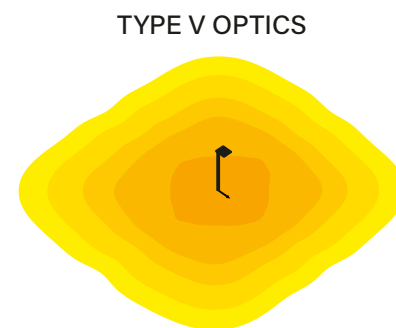
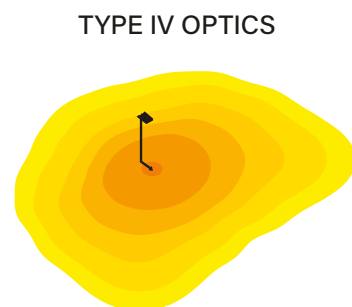
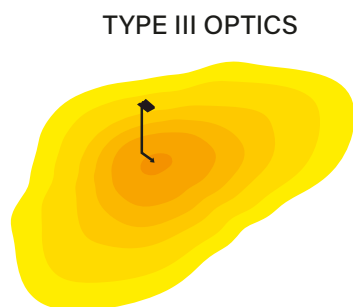

SHOWN OPEN WITH KEYSTONE DRIVER



MOTION SENSOR (OPTIONAL)



PHOTOCELL WITH 7-PIN NEMA TWIST-LOCK RECEPTACLE

Stocking Special Options

All the components you need in one simple package.

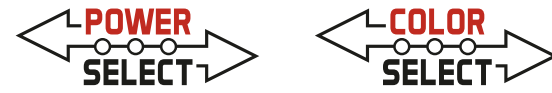

Area Lights with optic_{swap}

Package Includes:

- Pre-Installed Pole Mount
- Type III, IV, and V optic lenses
- Power and Color Selectable fixture
- Photocell
- Shorting Cap
- Available in Bronze or White



Area Lights with optic_{swap}

Package Includes:

- Pre-Installed Slipfitter Mount
- Type III, IV, and V optic lenses
- Power and Color Selectable fixture
- Photocell
- Shorting Cap
- Available in Bronze or White



Project Options— Area Lights with optic_{swap}

Customize your fixture package in 4 easy steps:



1. Select Fixture

120-277V

- POWER SELECT AND COLOR SELECT
Available in: Bronze, White, Silver, & Black



- DEDICATED
Available in: Bronze



277-480V

- POWER SELECT AND COLOR SELECT
Available in: Bronze



2. Select Included Optics

TYPE III

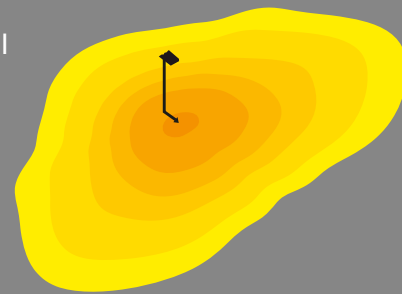

TYPE V

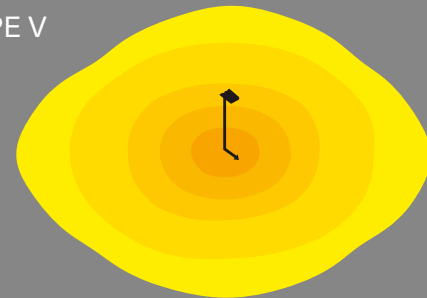

Additional Optics Available

TYPE II

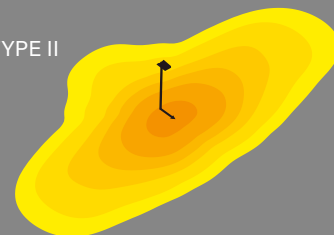

TYPE IV

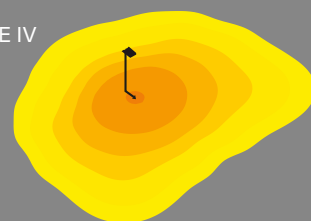

3. Select Mount

ADJUSTABLE
POLE MOUNT



FIXED POLE
MOUNT



SLIPFITTER
MOUNT



TRUNNION
MOUNT



4. Select Sensor

MOTION
SENSOR



DAYLIGHT
SENSOR



Select Additional Accessories:

- ACCESSORIES - PG 82-83
- POLES & ACCESSORIES - PG 84-85

Please consult with representative for pairing mounts and accessories before ordering.



XFIT

Dusk-to-Dawn Lights

Functional style to
withstand the rigors of
commercial applications

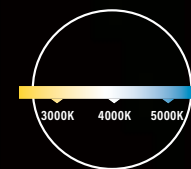

COLOR SELECT TECHNOLOGY (ON SELECT MODELS)

Adjustable: 3000K / 4000K / 5000K



POWER SELECT TECHNOLOGY (ON SELECT MODELS)

Reduce SKUs and increase both flexibility and convenience with field-adjustable power outputs (3 options)



BUILT-IN DUSK-TO-DAWN PHOTOCELL

With activation, automatically turns on/off when daylight is available for increased energy savings

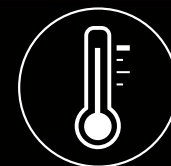

122°F / 50°C MAX AMBIENT TEMPERATURE

Designed to handle harsh conditions with ample heat sinking



50,000 HOUR
LIFETIME

IP65
RATED

10 YEAR
LIMITED WARRANTY

Dusk-to-Dawn Lights

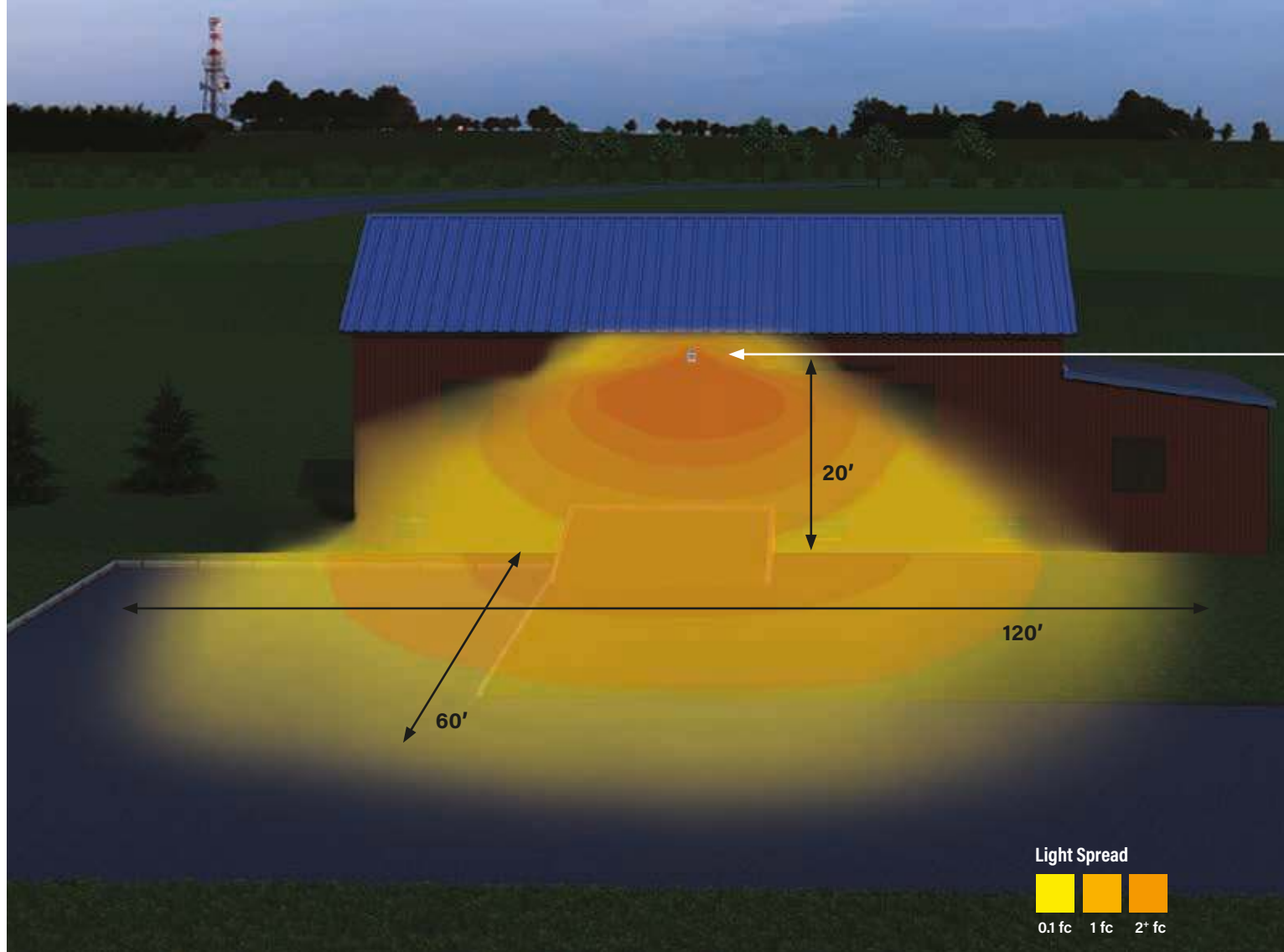

COLOR SELECT SWITCH



60W DUSK-TO-DAWN LIGHT



POWER SELECT SWITCH

FEATURES AND BENEFITS

- Compact design matches appearance and light distribution of legacy HID, optimized for one-to-one replacements
- Impact resistant and highly diffused poly carb lens with anti-yellowing agent offers reduced glare for low mounting height applications
- NEMA 3-pin photocell included
- Ensures reliable operation with a Keystone LED dimming driver
- Heavy-duty, die-cast aluminum housing with ample heat sinking for enhanced thermal performance

60W Dusk-to-Dawn Light:
Barn exterior mounted at 20'

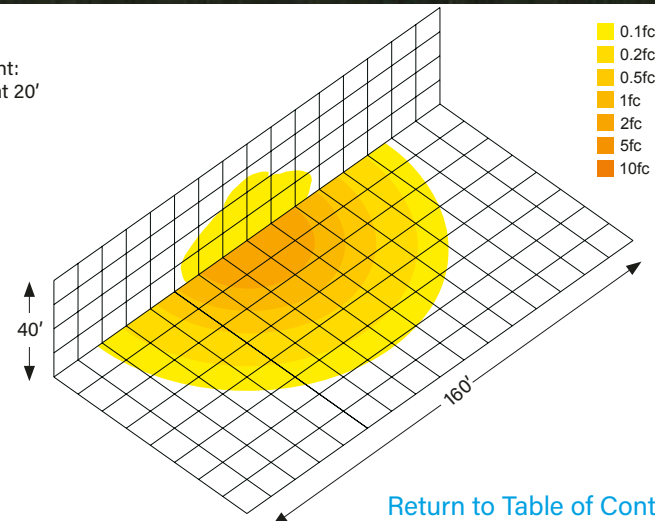

[Return to Table of Contents](#)



IMPACT-RESISTANT AND HIGHLY DIFFUSED POLYCARB LENS



DUSK-TO-DAWN FIXTURE WITH PHOTOCELL INCLUDED

Color Selection Ordering Guide

All lamps and fixtures in our catalog are available in a variety of color temperatures. While reviewing options, the guide below will help you identify the final product ID needed to order.



When a Keystone product has a catalog number that uses an "xx," it indicates that several color temperatures are available. The color temperatures for that product are noted in the accompanying chart.

Below is a quick reference guide to Keystone's color offering and how to easily select and order the right product for your job.

To order, simply replace the "xx" with the first two numbers from the corresponding color temperature.

Example:

To order a 4000K color temperature product, replace the "xx" in the catalog number with the two-digit number represented above the Kelvin desired as indicated in color chart below.

Catalog number with "xx"

KT-LED14.5T8-48G-8xx-DX2

Catalog number used to order a 4000K color temperature product

KT-LED14.5T8-48G-840-DX2

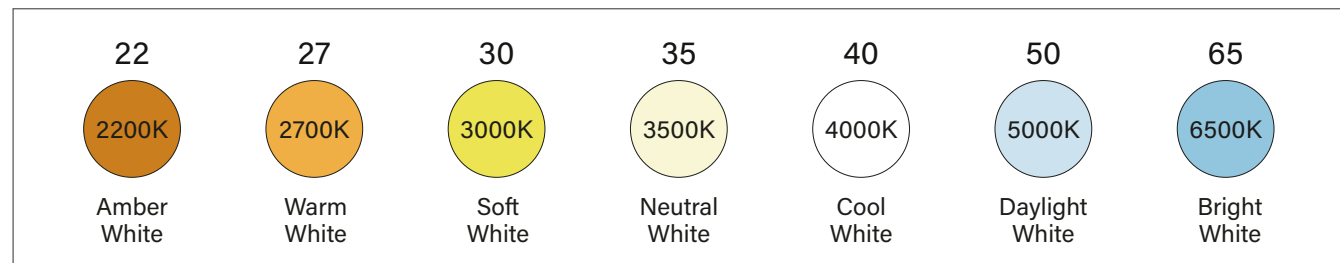

Power and Color Select

XFIT

CATALOG NUMBER	SELECTABLE WATTAGE	SELECTABLE CCT	LUMENS	EFFICACY	INPUT VOLTAGE	HOUSING COLOR	OPTICS TYPE*	DLC	CRI	METAL HALIDE EQUIVALENT
KT-FLED140PS-R4-OSF-UNV-8CSB-VDIM	140W	3000K	18200	130 lm/W	120-277V	Bronze	7H x 6V installed, 6H x 6V & 5H x 5V included	Yes	> 80	400W MH
		4000K	21000	150 lm/W						
		5000K	19600	140 lm/W						
	100W	3000K	14000	140 lm/W						
		4000K	16000	160 lm/W						
		5000K	15000	150 lm/W						
KT-FLED140PS-R4-OSF-UNV-8CSB-VDIM-W	140W	3000K	18200	130 lm/W	120-277V	White	7H x 6V installed, 6H x 6V & 5H x 5V included	Yes	> 80	400W MH
		4000K	21000	150 lm/W						
		5000K	19600	140 lm/W						
	100W	3000K	14000	140 lm/W						
		4000K	16000	160 lm/W						
		5000K	15000	150 lm/W						
KT-FLED290PS-R4-OSF-UNV-8CSB-VDIM	290W	3000K	37700	130 lm/W	120-277V	Bronze	7H x 6V installed, 6H x 6V & 5H x 5V included	Yes	> 80	1000W MH
		4000K	43500	150 lm/W						
		5000K	40600	140 lm/W						
	210W	3000K	29400	140 lm/W						
		4000K	33600	160 lm/W						
		5000K	31500	150 lm/W						
KT-FLED290PS-R4-OSF-UNV-8CSB-VDIM-W	290W	3000K	37700	130 lm/W	120-277V	White	7H x 6V installed, 6H x 6V & 5H x 5V included	Yes	> 80	1000W MH
		4000K	43500	150 lm/W						
		5000K	40600	140 lm/W						
	210W	3000K	29400	140 lm/W						
		4000K	33600	160 lm/W						
		5000K	31500	150 lm/W						



XFIT

High Voltage | Power and Color Select

CATALOG NUMBER	SELECTABLE WATTAGE	SELECTABLE CCT	LUMENS	EFFICACY	INPUT VOLTAGE	HOUSING COLOR	OPTICS TYPE*	DLC	CRI	METAL HALIDE EQUIVALENT
KT-FLED140PSHV-R4-OSF-UNV-8CSB-VDIM	140W	3000K	18200	130 lm/W	277-480V	Bronze	7H x 6V installed, 6H x 6V & 5H x 5V included	Yes	> 80	400W MH
		4000K	21000	150 lm/W						
		5000K	19600	140 lm/W						
	100W	3000K	14000	140 lm/W						
		4000K	16000	160 lm/W						
		5000K	15000	150 lm/W						

KT-FLED290PSHV-R4-OSF-UNV-8CSB-VDIM	290W	3000K	37700	130 lm/W	277-480V	Bronze	7H x 6V installed, 6H x 6V & 5H x 5V included	Yes	> 80	1000W MH
		4000K	43500	150 lm/W						
		5000K	40600	140 lm/W						
	210W	3000K	29400	140 lm/W						
		4000K	33600	160 lm/W						
		5000K	31500	150 lm/W						

Glare Shields

CATALOG NUMBER	DESCRIPTION
KT-FLED-GS-R4-1-KIT	Glare shield used on 140W Rectangular Series 4 LED Floodlight Bronze
KT-FLED-GS-R4-2-KIT	Glare shield used on 290W Rectangular Series 4 LED Floodlight Bronze
KT-FLED-GS-R4-1-KIT-W	Glare shield used on 140W Rectangular Series 4 LED Floodlight White
KT-FLED-GS-R4-2-KIT-W	Glare shield used on 290W Rectangular Series 4 LED Floodlight White



Power and Color Select

CATALOG NUMBER	SELECTABLE WATTAGE	SELECTABLE CCT	LUMENS	EFFICACY	INPUT VOLTAGE	HOUSING COLOR	OPTICS TYPE*	DLC	CRI	METAL HALIDE EQUIVALENT					
KT-FLED140PS-R2B-UNV-8CSB-VDIM	140W	3000K	17500	125 lm/W	120-277V	Bronze	7H x 6V	Yes	>80	400W MH					
KT-FLED140PS-R2C-UNV-8CSB-VDIM		4000K	19600	140 lm/W			6H x 6V								
		5000K	18900	135 lm/W			5H x 5V								
KT-FLED140PS-R2D-UNV-8CSB-VDIM	100W	3000K	13200	132 lm/W											
		4000K	14500	145 lm/W											
		5000K	14200	142 lm/W											
KT-FLED140PS-R2B-UNV-8CSB-VDIM-W	140W	3000K	17500	125 lm/W			120-277V				White	7H x 6V	Yes	>80	400W MH
KT-FLED140PS-R2C-UNV-8CSB-VDIM-W		4000K	19600	140 lm/W								6H x 6V			
		5000K	18900	135 lm/W								5H x 5V			
KT-FLED140PS-R2D-UNV-8CSB-VDIM-W	100W	3000K	13200	132 lm/W											
		4000K	14500	145 lm/W											
		5000K	14200	142 lm/W											
KT-FLED290PS-R2B-UNV-8CSB-VDIM	290W	3000K	34800	120 lm/W	120-277V	Bronze		7H x 6V	Yes	>80		1000W MH			
KT-FLED290PS-R2C-UNV-8CSB-VDIM		4000K	40600	140 lm/W				6H x 6V							
		5000K	37700	130 lm/W				5H x 5V							
KT-FLED290PS-R2D-UNV-8CSB-VDIM	210W	3000K	25620	122 lm/W											
		4000K	29820	142 lm/W											
		5000K	27720	132 lm/W											
KT-FLED290PS-R2B-UNV-8CSB-VDIM-W	290W	3000K	34800	120 lm/W			120-277V	White			7H x 6V		Yes	>80	1000W MH
KT-FLED290PS-R2C-UNV-8CSB-VDIM-W		4000K	40600	140 lm/W							6H x 6V				
		5000K	37700	130 lm/W							5H x 5V				
KT-FLED290PS-R2D-UNV-8CSB-VDIM-W	210W	3000K	25620	122 lm/W											
		4000K	29820	142 lm/W											
		5000K	27720	132 lm/W											

Fixtures with 6H x 6V & 5H x 5V optics are available and assembled to order. Lead times may apply

Floodlights | High Power



High Voltage | Power and Color Select

CATALOG NUMBER	SELECTABLE WATTAGE	SELECTABLE CCT	LUMENS	EFFICACY	INPUT VOLTAGE	HOUSING COLOR	OPTICS TYPE*	DLC	CRI	METAL HALIDE EQUIVALENT					
KT-FLED140PSHV-R2B-UNV-8CSB-VDIM	140W	3000K	17500	125 lm/W	277-480V	Bronze	7H x 6V	Yes	>80	400W MH					
		4000K	19600	140 lm/W			6H x 6V								
		5000K	18900	135 lm/W											
KT-FLED140PSHV-R2C-UNV-8CSB-VDIM	100W	3000K	13200	132 lm/W			277-480V				Bronze	6H x 6V	Yes	>80	1000W MH
		4000K	14500	145 lm/W								5H x 5V			
		5000K	14200	142 lm/W											
KT-FLED290PSHV-R2B-UNV-8CSB-VDIM	290W	3000K	34800	120 lm/W	277-480V	Bronze		7H x 6V	Yes	>80		1000W MH			
		4000K	40600	140 lm/W				6H x 6V							
		5000K	37700	130 lm/W											
KT-FLED290PSHV-R2C-UNV-8CSB-VDIM	210W	3000K	25620	122 lm/W			277-480V	Bronze			6H x 6V		Yes	>80	1000W MH
		4000K	29820	142 lm/W							5H x 5V				
		5000K	27720	132 lm/W											

*Fixtures with 6H x 6V & 5H x 5V optics are available and assembled to order. Lead times may apply

Components

CATALOG NUMBER	DESCRIPTION	
KTSP-10KV-C	External surge protector, compact design	

Glare Shields

CATALOG NUMBER	DESCRIPTION	
KT-FLED-GS-R2-1-KIT	Glare shield for 140W	
KT-FLED-GS-R2-2-KIT	Glare shield for 290W	
KT-FLED-GS-R2-1-KIT-W	Glare shield for 140W, white	
KT-FLED-GS-R2-2-KIT-W	Glare shield for 290W, white	

Floodlights



XFIT

Power and Color Select

CATALOG NUMBER	SELECTABLE WATTAGE	SELECTABLE CCT	LUMENS	EFFICACY	INPUT VOLTAGE	HOUSING COLOR	OPTICS TYPE	DLC	CRI	METAL HALIDE EQUIVALENT
KT-FLED15PS-R4A-UNV-8CSB-VDIM	15W	3000K	1950	130 lm/W	120-277V	Bronze	7H x 7V	Yes	> 80	70W MH
		4000K	2250	150 lm/W						
		5000K	2100	140 lm/W						
	12W	3000K	1584	132 lm/W						
		4000K	1836	153 lm/W						
		5000K	1716	143 lm/W						
	9W	3000K	1242	138 lm/W						
		4000K	1404	156 lm/W						
		5000K	1332	148 lm/W						
KT-FLED15PS-R4A-UNV-8CSB-VDIM-W	15W	3000K	1950	130 lm/W	120-277V	White	7H x 7V	Yes	> 80	70W MH
		4000K	2250	150 lm/W						
		5000K	2100	140 lm/W						
	12W	3000K	1584	132 lm/W						
		4000K	1836	153 lm/W						
		5000K	1716	143 lm/W						
	9W	3000K	1242	138 lm/W						
		4000K	1404	156 lm/W						
		5000K	1332	148 lm/W						
KT-FLED35PS-R4A-UNV-8CSB-VDIM	35W	3000K	4550	130 lm/W	120-277V	Bronze	7H x 7V	Yes	> 80	175W MH
		4000K	5250	150 lm/W						
		5000K	4900	140 lm/W						
	25W	3000K	3375	135 lm/W						
		4000K	3875	155 lm/W						
		5000K	3625	145 lm/W						
	15W	3000K	2100	140 lm/W						
		4000K	2400	160 lm/W						
		5000K	2250	150 lm/W						
KT-FLED35PS-R4A-UNV-8CSB-VDIM-W	35W	3000K	4550	130 lm/W	120-277V	White	7H x 7V	Yes	> 80	175W MH
		4000K	5250	150 lm/W						
		5000K	4900	140 lm/W						
	25W	3000K	3375	135 lm/W						
		4000K	3875	155 lm/W						
		5000K	3625	145 lm/W						
	15W	3000K	2100	140 lm/W						
		4000K	2400	160 lm/W						
		5000K	2250	150 lm/W						
KT-FLED60PS-R4A-UNV-8CSB-VDIM	60W	3000K	7800	130 lm/W	120-277V	Bronze	7H x 7V	Yes	> 80	250W MH
		4000K	9000	150 lm/W						
		5000K	8400	140 lm/W						
	50W	3000K	6650	133 lm/W						
		4000K	7750	155 lm/W						
		5000K	7250	145 lm/W						
	40W	3000K	5600	140 lm/W						
		4000K	6400	160 lm/W						
		5000K	6000	150 lm/W						

Chart continues on next page

Floodlights

Chart continued from previous page



XFIT

Power and Color Select

CATALOG NUMBER	SELECTABLE WATTAGE	SELECTABLE CCT	LUMENS	EFFICACY	INPUT VOLTAGE	HOUSING COLOR	OPTICS TYPE	DLC	CRI	METAL HALIDE EQUIVALENT							
KT-FLED60PS-R4A-UNV-8CSB-VDIM-W	60W	3000K	7800	130 lm/W	120-277V	White	7H x 7V	Yes	> 80	250W MH							
		4000K	9000	150 lm/W													
		5000K	8400	140 lm/W													
	50W	3000K	6650	133 lm/W													
		4000K	7750	155 lm/W													
		5000K	7250	145 lm/W													
	40W	3000K	5600	140 lm/W													
		4000K	6400	160 lm/W													
		5000K	6000	150 lm/W													
KT-FLED75PS-R4A-UNV-8CSB-VDIM	75W	3000K	9750	130 lm/W	120-277V	Bronze	7H x 7V	Yes	> 80	320W MH							
		4000K	11250	150 lm/W													
		5000K	10500	140 lm/W													
	60W	3000K	8280	138 lm/W													
		4000K	9480	158 lm/W													
		5000K	8880	148 lm/W													
	45W	3000K	6390	142 lm/W													
		4000K	7290	162 lm/W													
		5000K	6840	152 lm/W													
	KT-FLED75PS-R4A-UNV-8CSB-VDIM-W	75W	3000K	9750							130 lm/W	120-277V	White	7H x 7V	Yes	> 80	320W MH
			4000K	11250							150 lm/W						
			5000K	10500							140 lm/W						
60W		3000K	8280	138 lm/W													
		4000K	9480	158 lm/W													
		5000K	8880	148 lm/W													
45W		3000K	6390	142 lm/W													
		4000K	7290	162 lm/W													
		5000K	6840	152 lm/W													
KT-FLED100PS-R4A-UNV-8CSB-VDIM		100W	3000K	13000	130 lm/W	120-277V	Bronze	7H x 7V	Yes	> 80	400W MH						
			4000K	15000	150 lm/W												
			5000K	14000	140 lm/W												
	90W	3000K	12150	135 lm/W													
		4000K	13950	155 lm/W													
		5000K	13050	145 lm/W													
	80W	3000K	11200	140 lm/W													
		4000K	12800	160 lm/W													
		5000K	12000	150 lm/W													
	KT-FLED100PS-R4A-UNV-8CSB-VDIM-W	100W	3000K	13000	130 lm/W							120-277V	White	7H x 7V	Yes	> 80	400W MH
			4000K	15000	150 lm/W												
			5000K	14000	140 lm/W												
90W		3000K	12150	135 lm/W													
		4000K	13950	155 lm/W													
		5000K	13050	145 lm/W													
80W		3000K	11200	140 lm/W													
		4000K	12800	160 lm/W													
		5000K	12000	150 lm/W													

Floodlights



XFIT

Color Select

CATALOG NUMBER	WATTAGE	SELECTABLE CCT	LUMENS	EFFICACY	INPUT VOLTAGE	HOUSING COLOR	OPTICS TYPE	DLC	CRI	METAL HALIDE EQUIVALENT
KT-FLED15-R1A-UNV-8CSB-VDIM	15W	3000K	1920	128 lm/W	120-277V	Bronze	7H x 7V	Yes	>80	70W MH
		4000K	2175	145 lm/W						
		5000K	2100	140 lm/W						
KT-FLED15-R1A-UNV-8CSB-VDIM-W	15W	3000K	1920	128 lm/W	120-277V	White	7H x 7V	Yes	>80	70W MH
		4000K	2175	145 lm/W						
		5000K	2100	140 lm/W						
KT-FLED35-R1A-UNV-8CSB-VDIM	35W	3000K	4480	128 lm/W	120-277V	Bronze	7H x 7V	Yes	>80	175W MH
		4000K	5075	145 lm/W						
		5000K	4900	140 lm/W						
KT-FLED35-R1A-UNV-8CSB-VDIM-W	35W	3000K	4480	128 lm/W	120-277V	White	7H x 7V	Yes	>80	175W MH
		4000K	5075	145 lm/W						
		5000K	4900	140 lm/W						
KT-FLED60-R1A-UNV-8CSB-VDIM	60W	3000K	7320	122 lm/W	120-277V	Bronze	7H x 7V	Yes	>80	250W MH
		4000K	8580	143 lm/W						
		5000K	8040	134 lm/W						
KT-FLED60-R1A-UNV-8CSB-VDIM-W	60W	3000K	7320	122 lm/W	120-277V	White	7H x 7V	Yes	>80	250W MH
		4000K	8580	143 lm/W						
		5000K	8040	134 lm/W						
KT-FLED75-R1A-UNV-8CSB-VDIM	75W	3000K	9150	122 lm/W	120-277V	Bronze	7H x 7V	Yes	>80	320W MH
		4000K	10725	143 lm/W						
		5000K	10050	134 lm/W						
KT-FLED75-R1A-UNV-8CSB-VDIM-W	75W	3000K	9150	122 lm/W	120-277V	White	7H x 7V	Yes	>80	320W MH
		4000K	10725	143 lm/W						
		5000K	10050	134 lm/W						
KT-FLED100-R1A-UNV-8CSB-VDIM	100W	3000K	12200	122 lm/W	120-277V	Bronze	7H x 7V	Yes	>80	400W MH
		4000K	14300	143 lm/W						
		5000K	13400	134 lm/W						
KT-FLED100-R1A-UNV-8CSB-VDIM-W	100W	3000K	12200	122 lm/W	120-277V	White	7H x 7V	Yes	>80	400W MH
		4000K	14300	143 lm/W						
		5000K	13400	134 lm/W						

Contractor Prime

XFIT

CATALOG NUMBER	WATTAGE	LUMENS	EFFICACY	INPUT VOLTAGE	HOUSING COLOR	OPTICS TYPE	CRI	MH EQUIVALENT	AVAILABLE CCTS
KT-FLED15-R3A-KM-8xx	15W	1725	115 lm/W	120/277V	Bronze	7H x 7V	>80	70W MH	3000K or 5000K

Floodlights



Components

CATALOG NUMBER	DESCRIPTION	
KTSP-10KV-C	External surge protector, compact design	

Mounts and Brackets | Power and Color Select

CATALOG NUMBER	DESCRIPTION	
KT-FLED-WG-R4-1-KIT	Wire guard for 15W Rectangular Series 4 LED floodlight	
KT-FLED-WG-R4-2-KIT	Wire guard for 35W Rectangular Series 4 LED floodlight	
KT-FLED-WG-R4-3-KIT	Wire guard for 60W Rectangular Series 4 LED floodlight	
KT-FLED-WG-R4-4-KIT	Wire guard for 75W and 100W Rectangular Series 4 LED floodlight	



Mounts and Brackets | Color Select

CATALOG NUMBER	DESCRIPTION	
KT-FLED-WG-1-KIT	Wire guard for 15W Rectangular Series 1 LED floodlight	
KT-FLED-WG-2-KIT	Wire guard for 35W Rectangular Series 1 LED floodlight	
KT-FLED-WG-3-KIT	Wire guard for 60W Rectangular Series 1 LED floodlight	
KT-FLED-WG-4-KIT	Wire guard for 75W and 100W Rectangular Series 1 LED floodlight	

Floodlights



Mounts and Brackets

CATALOG NUMBER	DESCRIPTION	
KT-FLED-SM-1-KIT	Surface mount kit, includes mounting hardware Bronze	
KT-FLED-SM-1-KIT-W	Surface mount kit, includes mounting hardware White	
KT-FLED-KM-1-KIT	Knuckle mount for 75W and 100W Rectangular Series 1 and 4 LED floodlight Bronze	
KT-FLED-KM-1-KIT-W	Knuckle mount for 75W and 100W Rectangular Series 1 and 4 LED floodlight White	
KT-FLED-SF-1-KIT	Slipfitter mount adapter for 15W, 35W, and 60W Rectangular Series 1 and 4 LED floodlight Bronze	
KT-FLED-SF-1-KIT-W	Slipfitter mount adapter for 15W, 35W, and 60W Rectangular Series 1 and 4 LED floodlight White	
KT-FLED-RC-4	Round cover plate Bronze	
KT-FLED-RC-4-W	Round cover plate White	

Sports Light

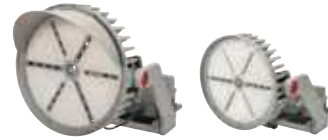

Dedicated

CATALOG NUMBER	WATTAGE	CCT	LUMENS	EFFICACY	INPUT VOLTAGE	HOUSING COLOR	DIMMING	BEAM ANGLE	CRI	DLC	LEGACY EQUIVALENT
KT-SLFLED500-S1-20-YM-750-VDIM	500W	5000K	70000	140 lm/W	120-277V	Gray	0-10V	20°	70	Yes	1500W MH
KT-SLFLED500-S1-30-YM-750-VDIM								30°			
KT-SLFLED500-S1-40-YM-750-VDIM								40°			
KT-SLFLED750-M1-20-YM-750-VDIM	750W	5000K	105000	140 lm/W	120-277V	Gray	0-10V	20°	70	Yes	2000W MH
KT-SLFLED750-M1-30-YM-750-VDIM								30°			
KT-SLFLED750-M1-40-YM-750-VDIM								40°			

High Voltage

CATALOG NUMBER	WATTAGE	CCT	LUMENS	EFFICACY	INPUT VOLTAGE	HOUSING COLOR	DIMMING	BEAM ANGLE	CRI	DLC	LEGACY EQUIVALENT
KT-SLFLED500HV-S1-20-YM-750-VDIM	500W	5000K	70000	140 lm/W	208-480V	Gray	0-10V	20°	70	Yes	1500W MH
KT-SLFLED500HV-S1-30-YM-750-VDIM								30°			
KT-SLFLED500HV-S1-40-YM-750-VDIM								40°			
KT-SLFLED750HV-M1-20-YM-750-VDIM	750W	5000K	105000	140 lm/W	208-480V	Gray	0-10V	20°	70	Yes	2000W MH
KT-SLFLED750HV-M1-30-YM-750-VDIM								30°			
KT-SLFLED750HV-M1-40-YM-750-VDIM								40°			

Sports Light



Control Accessories

CATALOG NUMBER	DESCRIPTION	
KT-TLP-UV-3PN	NEMA Type 3-pin photocell; 120-277V; 1800VA max	
KT-TLP-HV-3PN	NEMA Type 3-pin photocell; 277-480V; 1800VA max	

Performance Accessories

CATALOG NUMBER	DESCRIPTION	
KT-SLFLED-EC-35	35' extension cord to remote mount LED driver for SLFLED fixtures	
KT-SLFLED-EC-65	65' extension cord to remote mount LED driver for SLFLED fixtures	
KT-SLFLED-LASER-G	Green laser pointer for Sports Light Flood aiming. Includes hardware to mount to SLFLED fixtures	

Mounts & Brackets

CATALOG NUMBER	DESCRIPTION	
KT-SLFLED-SF-S1-KIT	Slipfitter mount kit for Series 1 Sports Light Flood, Small Housing. Fits 2 3/8" tenon	
KT-SLFLED-SF-M1-KIT	Slipfitter mount kit for Series 1 Sports Light Flood, Medium Housing. Fits 2 3/8" tenon	
KT-SLFLED-KM-1-KIT	Knuckle mount for 500W LED Sports Light Flood, Small	
KT-SLFLED-KM-2-KIT	Knuckle mount for 500W LED Sports Light Flood, Medium	



Floodlights | Bullet



Power and Color Select

CATALOG NUMBER	WATTAGE	SELECTABLE CCT	LUMENS	EFFICACY	INPUT VOLTAGE	DIMMING	HOUSING COLOR	OPTICS TYPE	DLC	CRI
KT-FLED25PS-C1E-UNV-8CSB-VDIM	25W	3000K	2970	119 lm/W	120-277V	0-10V	Bronze	4H x 4V	Yes	>80
		4000K	3290	132 lm/W						
		5000K	3270	131 lm/W						
	20W	3000K	2400	120 lm/W						
		4000K	2610	131 lm/W						
		5000K	2580	129 lm/W						
	15W	3000K	1860	124 lm/W						
		4000K	2000	133 lm/W						
		5000K	1990	133 lm/W						
KT-FLED25PS-C1E-UNV-8CSB-VDIM-W	25W	3000K	2970	119 lm/W	120-277V	0-10V	White	4H x 4V	Yes	>80
		4000K	3290	132 lm/W						
		5000K	3270	131 lm/W						
	20W	3000K	2400	120 lm/W						
		4000K	2610	131 lm/W						
		5000K	2580	129 lm/W						
	15W	3000K	1860	124 lm/W						
		4000K	2000	133 lm/W						
		5000K	1990	133 lm/W						

Accessories | Lens Kits

CATALOG NUMBER	DESCRIPTION	
KT-FLED-LENS-C1-BLUE-KIT	NEMA 4H x 4V and 3H x 3V blue lens kit for Series 1 Bullet Floodlight	
KT-FLED-LENS-C1-GREEN-KIT	NEMA 4H x 4V and 3H x 3V green lens kit for Series 1 Bullet Floodlight	
KT-FLED-LENS-C1-RED-KIT	NEMA 4H x 4V and 3H x 3V red lens kit for Series 1 Bullet Floodlight	



Wall Washers | DMX Linear



RGBW

CATALOG NUMBER	LENGTH	WATTAGE	COLOR	LUMEN OUTPUT	EFFICACY	INPUT VOLTAGE	LIGHT DISTRIBUTION	RATED LIFE
KT-WWLED12-L2A-M-RGBW-DMX	2ft	12W	RGBW	560	45 lm/W	120 - 277V	Medium	50,000 Hours
KT-WWLED24-L4A-M-RGBW-DMX	4ft	24W	RGBW	1110	45 lm/W	120 - 277V	Medium	50,000 Hours

Controllers and Cables

CATALOG NUMBER	DESCRIPTION	
KTSL-DMXC1-UV-WC	SmartLoop Wireless DMX Controller. 120-277V input proprietary waterproof connector for use with Keystone RGBW wall wash fixtures	
KTSL-DMXC1-1-WC	SmartLoop Wireless DMX Controller. 120V input with NEMA 5-15P proprietary connector for use with Keystone RGBW wall wash fixtures	
KT-WWLED-DMX-6-WC/XLR	6' long 3 wire input cord, 120-277V, with proprietary waterproof connector and standard 3-pin XLR connector, for use with Keystone RGBW wall wash fixtures when controlling via 3rd party DMX controller	

Linking Cables

CATALOG NUMBER	DESCRIPTION	
KT-WWLED-DMX-1-LCS	1' long linking cord set to daisy-chain line voltage & DMX Signal	
KT-WWLED-DMX-6-LCS	6' long linking cord set to daisy-chain line voltage & DMX Signal	
KT-WWLED-DMX-15-LCS	15' long linking cord set to daisy-chain line voltage & DMX Signal	

Mounts and Brackets

CATALOG NUMBER	DESCRIPTION	
KT-WWLED-LA-WMB-KIT	Wall mount bracket kit for Linear Series A wall washers. Set of 2. Adjustable distance 12" to 24" set back from wall. (Compatible with standard fixture mounting or hinged bracket accessories.)	

Wall Packs | Traditional-Slim



Power and Color Select

CATALOG NUMBER	SELECTABLE WATTAGE	SELECTABLE CCT	LUMENS	EFFICACY	INPUT VOLTAGE	DIMMING	CRI	PHOTOCELL INCLUDED	HOUSING COLOR	LEGACY EQUIVALENT							
KT-WPLED35PS-M4-8CSB-VDIM	35W	3000K	4550	130 lm/W	120-277V	0-10V	>80	Yes	Bronze	175W MH							
		4000K	4655	133 lm/W													
		5000K	4620	132 lm/W													
	25W	3000K	3400	136 lm/W													
		4000K	3525	141 lm/W													
		5000K	3475	139 lm/W													
	15W	3000K	2100	140 lm/W													
		4000K	2160	144 lm/W													
		5000K	2160	144 lm/W													
KT-WPLED55PS-M4-8CSB-VDIM	55W	3000K	7260	132 lm/W	120-277V	0-10V	>80	Yes	Bronze	250W MH							
		4000K	7645	139 lm/W													
		5000K	7370	134 lm/W													
	45W	3000K	6120	136 lm/W													
		4000K	6435	143 lm/W													
		5000K	6255	139 lm/W													
	35W	3000K	4900	140 lm/W													
		4000K	5075	145 lm/W													
		5000K	5005	143 lm/W													
	KT-WPLED80PS-M4-8CSB-VDIM	80W	3000K	10560							132 lm/W	120-277V	0-10V	>80	Yes	Bronze	320W MH
			4000K	11280							141 lm/W						
			5000K	10960							137 lm/W						
70W		3000K	9380	134 lm/W													
		4000K	10010	143 lm/W													
		5000K	9800	140 lm/W													
55W		3000K	7645	139 lm/W													
		4000K	8030	146 lm/W													
		5000K	7975	145 lm/W													
KT-WPLED120PS-L4-8CSB-VDIM		120W	3000K	17040	142 lm/W	120-277V	0-10V	>80	Yes	Bronze	400W MH						
			4000K	17640	147 lm/W												
			5000K	16920	141 lm/W												
	100W	3000K	13900	139 lm/W													
		4000K	14300	143 lm/W													
		5000K	13900	139 lm/W													
	80W	3000K	11280	141 lm/W													
		4000K	11520	144 lm/W													
		5000K	11440	143 lm/W													

Mounts and Brackets

CATALOG NUMBER	DESCRIPTION	
KT-WPLED-BP-M	Standard bronze back plate for medium-sized wall pack to cover footprint of large HID housings	

Sensors

CATALOG NUMBER	DESCRIPTION	
KTS-MW3-UV-KO-K1	Microwave sensor kit, includes 120-277V input to 12V DC converter and 12V input sensor head, IP65, bi-level control with adjustable hold time, dim level and standby time, installs via standard 1/2 in KO	

Wall Packs | Traditional



Color Select

CATALOG NUMBER	WATTAGE	SELECTABLE CCT	LUMENS	EFFICACY	INPUT VOLTAGE	HOUSING COLOR	DLC	CRI	METAL HALIDE EQUIVALENT
KT-WPLED35-M1-8CSB-VDIM	35W	3000K	4885	140 lm/W	120-277V	Bronze	Yes	>80	150W MH
		4000K	5460	156 lm/W					
		5000K	5010	143 lm/W					
KT-WPLED35-M1-8CSB-VDIM-W	35W	3000K	4885	140 lm/W	120-277V	White	Yes	>80	150W MH
		4000K	5460	156 lm/W					
		5000K	5010	143 lm/W					
KT-WPLED55-M1-8CSB-VDIM	55W	3000K	7200	131 lm/W	120-277V	Bronze	Yes	>80	250W MH
		4000K	7690	140 lm/W					
		5000K	7450	135 lm/W					
KT-WPLED55-M1-8CSB-VDIM-W	55W	3000K	7200	131 lm/W	120-277V	White	Yes	>80	250W MH
		4000K	7690	140 lm/W					
		5000K	7450	135 lm/W					
KT-WPLED80-M1-8CSB-VDIM	80W	3000K	10955	137 lm/W	120-277V	Bronze	Yes	>80	320W MH
		4000K	11925	149 lm/W					
		5000K	11360	142 lm/W					
KT-WPLED80-M1-8CSB-VDIM-W	80W	3000K	10955	137 lm/W	120-277V	White	Yes	>80	320W MH
		4000K	11925	149 lm/W					
		5000K	11360	142 lm/W					
KT-WPLED120-L1-8CSB-VDIM	120W	3000K	16410	137 lm/W	120-277V	Bronze	Yes	>80	400W MH
		4000K	17865	149 lm/W					
		5000K	16900	141 lm/W					
KT-WPLED120-L1-8CSB-VDIM-W	120W	3000K	16410	137 lm/W	120-277V	White	Yes	>80	400W MH
		4000K	17865	149 lm/W					
		5000K	16900	141 lm/W					

Wall Packs | Traditional



Sensors

CATALOG NUMBER	DESCRIPTION	
KTS-MW3-UV-KO-K1	Microwave sensor kit, includes 120-277V input to 12V DC convertor and 12V input sensor head, IP65, bi-level control with adjustable hold time, dim level and standby time, installs via standard 1/2 in KO	

Components

CATALOG NUMBER	DESCRIPTION	
KTSP-10KV-C	External surge protector, compact design	

Mounts and Brackets

CATALOG NUMBER	DESCRIPTION	
KT-WPLED-BP-M	Standard bronze back plate for medium-sized wall pack to cover footprint of large HID housings	



Wall Packs | Full Cutoff



Dedicated

CATALOG NUMBER	WATTAGE	LUMENS	EFFICACY	INPUT VOLTAGE	HOUSING COLOR	DLC	CRI	AVAILABLE CCT	METAL HALIDE EQUIVALENT
KT-WPLED40-M2-8xx-VDIM	40W	5200	130 lm/W	120-277V	Bronze	Yes	>80	4000K or 5000K	175W MH
KT-WPLED60-M2-8xx-VDIM	60W	7800	130 lm/W	120-277V	Bronze	Yes	>80	4000K or 5000K	250W MH
KT-WPLED100-M2-8xx-VDIM	100W	13000	130 lm/W	120-277V	Bronze	Yes	>80	4000K or 5000K	400W MH

Components

CATALOG NUMBER	DESCRIPTION	
KTSP-10KV-C	External surge protector, compact design	
KT-WPLED-PS-UV-KO	Dusk-to-dawn photocell, installed behind existing translucent KO on fixture	

Sensors

CATALOG NUMBER	DESCRIPTION	
KTS-MW3-UV-KO-K1	Microwave sensor kit, includes 120-277V input to 12V DC convertor and 12V input sensor head, IP65, bi-level control with adjustable hold time, dim level and standby time, installs via standard 1/2 in KO	

Mounts and Brackets

CATALOG NUMBER	DESCRIPTION	
KT-WPLED-BP-M	Standard bronze back plate for medium-sized wall pack to cover footprint of large HID housings	

Wall Packs | Adjustable



Power and Color Select

CATALOG NUMBER	SELECTABLE WATTAGE	SELECTABLE CCT	LUMENS	EFFICACY	INPUT VOLTAGE	DIMMING	HOUSING COLOR	DLC	CRI	METAL HALIDE EQUIVALENT
KT-WPLED35PS-S3-8CSB-VDIM	35W	3000K	4380	125 lm/W	120-277V	0-10V	Bronze	Yes	>80	150W MH
		4000K	5080	145 lm/W						
		5000K	4730	135 lm/W						
	25W	3000K	3380	135 lm/W						
		4000K	3750	150 lm/W						
		5000K	3630	145 lm/W						
	15W	3000K	2180	145 lm/W						
		4000K	2330	155 lm/W						
		5000K	2250	150 lm/W						
KT-WPLED35PS-S3-8CSB-VDIM-W	35W	3000K	4380	125 lm/W	120-277V	0-10V	White	Yes	>80	150W MH
		4000K	5080	145 lm/W						
		5000K	4730	135 lm/W						
	25W	3000K	3380	135 lm/W						
		4000K	3750	150 lm/W						
		5000K	3630	145 lm/W						
	15W	3000K	2180	145 lm/W						
		4000K	2330	155 lm/W						
		5000K	2250	150 lm/W						
KT-WPLED75PS-M3-8CSB-VDIM	75W	3000K	9380	125 lm/W	120-277V	0-10V	Bronze	Yes	>80	320W MH
		4000K	10880	145 lm/W						
		5000K	10130	135 lm/W						
	60W	3000K	8100	135 lm/W						
		4000K	9000	150 lm/W						
		5000K	8700	145 lm/W						
	45W	3000K	6320	140 lm/W						
		4000K	6980	155 lm/W						
		5000K	6750	150 lm/W						
KT-WPLED75PS-M3-8CSB-VDIM-W	75W	3000K	9380	125 lm/W	120-277V	0-10V	White	Yes	>80	320W MH
		4000K	10880	145 lm/W						
		5000K	10130	135 lm/W						
	60W	3000K	8100	135 lm/W						
		4000K	9000	150 lm/W						
		5000K	8700	145 lm/W						
	45W	3000K	6320	140 lm/W						
		4000K	6980	155 lm/W						
		5000K	6750	150 lm/W						

Small Low-Profile | Traditional



Color Select | Integral Emergency Backup

CATALOG NUMBER	WATTAGE	SELECTABLE CCT	LUMENS	EFFICACY	INPUT VOLTAGE	HOUSING COLOR	DLC	CRI	METAL HALIDE EQUIVALENT
KT-WPLED20-S1-8CSB-VDIM /EM4	20W	3000K	2500	125 lm/W	120-277V	Bronze	Yes	>80	70W MH
		4000K	2700	135 lm/W					
		5000K	2600	130 lm/W					

Color Select

CATALOG NUMBER	WATTAGE	SELECTABLE CCT	LUMENS	EFFICACY	INPUT VOLTAGE	HOUSING COLOR	DLC	CRI	METAL HALIDE EQUIVALENT
KT-WPLED20-S1-8CSB-VDIM	20W	3000K	2500	125 lm/W	120-277V	Bronze	Yes	>80	70W MH
		4000K	2700	135 lm/W					
		5000K	2600	130 lm/W					
KT-WPLED20-S1-8CSB-VDIM-W	20W	3000K	2500	125 lm/W	120-277V	White	Yes	>80	70W MH
		4000K	2700	135 lm/W					
		5000K	2600	130 lm/W					
KT-WPLED20-S1-8CSB-VDIM-B	20W	3000K	2500	125 lm/W	120-277V	Black	Yes	>80	70W MH
		4000K	2700	135 lm/W					
		5000K	2600	130 lm/W					

Dedicated

CATALOG NUMBER	WATTAGE	LUMENS	EFFICACY	INPUT VOLTAGE	HOUSING COLOR	DLC	CRI	METAL HALIDE EQUIVALENT	AVAILABLE CCT
KT-WPLED20-S1-8xx-VDIM	20W	2500	125 lm/W	120-277V	Bronze	Yes	>80	70W MH	4000K or 5000K

Components

CATALOG NUMBER	DESCRIPTION
KTSP-10KV-C	External surge protector, compact design



Canopy Fixtures



Power and Color Select

CATALOG NUMBER	NOMINAL SIZE	SELECTABLE WATTAGE	SELECTABLE CCT	LUMENS	EFFICACY	INPUT VOLTAGE	DIMMING	CRI	DISTRIBUTION	HOUSING COLOR	LEGACY EQUIVALENT
KT-CLED60PS-M1-8CSB-VDIM	10" square	60W	3000K	7500	125 lm/W	120-277V	0-10V	>80	160°	Bronze	250W MH
			4000K	8400	140 lm/W						
			5000K	7800	130 lm/W						
		50W	3000K	6250	125 lm/W						
			4000K	7000	140 lm/W						
			5000K	6500	130 lm/W						
		40W	3000K	5000	125 lm/W						
			4000K	5600	140 lm/W						
			5000K	5200	130 lm/W						
KT-CLED40PS-S1-8CSB-VDIM	8" square	40W	3000K	5000	125 lm/W	120-277V	0-10V	>80	160°	Bronze	175W MH
			4000K	5600	140 lm/W						
			5000K	5200	130 lm/W						
		30W	3000K	3750	125 lm/W						
			4000K	4200	140 lm/W						
			5000K	3900	130 lm/W						
		20W	3000K	2500	125 lm/W						
			4000K	2800	140 lm/W						
			5000K	2600	130 lm/W						
KT-CLED40PS-S1-8CSB-VDIM-W	8" square	40W	3000K	5000	125 lm/W	120-277V	0-10V	>80	160°	White	175W MH
			4000K	5600	140 lm/W						
			5000K	5200	130 lm/W						
		30W	3000K	3750	125 lm/W						
			4000K	4200	140 lm/W						
			5000K	3900	130 lm/W						
		20W	3000K	2500	125 lm/W						
			4000K	2800	140 lm/W						
			5000K	2600	130 lm/W						
KT-CLED25PS-S1-8CSB-VDIM	8" square	25W	3000K	3125	125 lm/W	120-277V	0-10V	>80	160°	Bronze	100W MH
			4000K	3500	140 lm/W						
			5000K	3250	130 lm/W						
		20W	3000K	2500	125 lm/W						
			4000K	2800	140 lm/W						
			5000K	2600	130 lm/W						
		15W	3000K	1875	125 lm/W						
			4000K	2100	140 lm/W						
			5000K	1950	130 lm/W						

Dedicated

CATALOG NUMBER	NOMINAL SIZE	WATTAGE	LUMENS	EFFICACY	INPUT VOLTAGE	DIMMING	CRI	DISTRIBUTION	HOUSING COLOR	LEGACY EQUIVALENT	AVAILABLE CCT
KT-CLED40-S1-850-VDIM	8" square	40W	5600	140 lm/W	120-277V	0-10V	>80	160°	Bronze	175W MH	5000K

Accessories

CATALOG NUMBER	DESCRIPTION
KT-CLED-LENS-M1-110-KIT	110° beam angle lens for 10" square canopy
KT-CLED-LENS-S1-110-KIT	110° beam angle lens for 8" square canopy
KT-CLED-BP-15	Mounting back plate for canopy fixtures, bronze
KT-CLED-BP-15-W	Mounting back plate for canopy fixtures, white

Sensors

CATALOG NUMBER	DESCRIPTION
KTS-MW3-12V-PKO /A*	Screw-in microwave sensor, preset for 1 min hold time, 3 min standby time at 30% dim, daylight disabled
KTS-MW3-12V-PKO /B*	Screw-in microwave sensor, preset for 5 min hold time, 10 min standby time at 10% dim, daylight disabled
KTSL-FC4-12V-PKO	Bluetooth mesh screw-in fixture controller for SmartLoop system

*Sensor comes preset with these settings.

Area Lights | Stocking Special Solutions

with **opticswap**



120-277V | Power and Color Select

CATALOG NUMBER	SELECTABLE WATTAGE	SELECTABLE CCT	LUMENS	EFFICACY	INPUT VOLTAGE	DIMMING	CRI	DISTRIBUTION PATTERN	PHOTOCELL INCLUDED	HOUSING COLOR	LEGACY EQUIVALENT
KT-ALED140PS-M2-OSB-PMA-8CSB-VDIM-P	140W	3000K	17950	128 lm/W	120-277V	0-10V	>80	Type III installed, Types IV and V included	Yes	Bronze	400W MH
		4000K	20780	148 lm/W							
		5000K	19020	136 lm/W							
	100W	3000K	12720	127 lm/W							
		4000K	14750	148 lm/W							
		5000K	13530	135 lm/W							
	70W	3000K	9310	133 lm/W							
		4000K	10740	153 lm/W							
		5000K	9880	141 lm/W							
KT-ALED140PS-M2-OSB-PMA-8CSB-VDIM-P-W	140W	3000K	17950	128 lm/W	120-277V	0-10V	>80	Type III installed, Types IV and V included	Yes	White	400W MH
		4000K	20780	148 lm/W							
		5000K	19020	136 lm/W							
	100W	3000K	12720	127 lm/W							
		4000K	14750	148 lm/W							
		5000K	13530	135 lm/W							
	70W	3000K	9310	133 lm/W							
		4000K	10740	153 lm/W							
		5000K	9880	141 lm/W							
KT-ALED140PS-M2-OSB-SF-8CSB-VDIM-P	140W	3000K	17950	128 lm/W	120-277V	0-10V	>80	Type III installed, Types IV and V included	Yes	Bronze	400W MH
		4000K	20780	148 lm/W							
		5000K	19020	136 lm/W							
	100W	3000K	12720	127 lm/W							
		4000K	14750	148 lm/W							
		5000K	13530	135 lm/W							
	70W	3000K	9310	133 lm/W							
		4000K	10740	153 lm/W							
		5000K	9880	141 lm/W							
KT-ALED140PS-M2-OSB-SF-8CSB-VDIM-P-W	140W	3000K	17950	128 lm/W	120-277V	0-10V	>80	Type III installed, Types IV and V included	Yes	White	400W MH
		4000K	20780	148 lm/W							
		5000K	19020	136 lm/W							
	100W	3000K	12720	127 lm/W							
		4000K	14750	148 lm/W							
		5000K	13530	135 lm/W							
	70W	3000K	9310	133 lm/W							
		4000K	10740	153 lm/W							
		5000K	9880	141 lm/W							
KT-ALED290PS-L2-OSB-PMA-8CSB-VDIM-P	290W	3000K	36320	125 lm/W	120-277V	0-10V	>80	Type III installed, Types IV and V included	Yes	Bronze	1000W MH
		4000K	42770	147 lm/W							
		5000K	38700	133 lm/W							
	210W	3000K	27300	130 lm/W							
		4000K	31710	151 lm/W							
		5000K	28980	138 lm/W							
	185W	3000K	22970	124 lm/W							
		4000K	27060	146 lm/W							
		5000K	24440	132 lm/W							

Chart continues on next page



120-277V | Power and Color Select

CATALOG NUMBER	SELECTABLE WATTAGE	SELECTABLE CCT	LUMENS	EFFICACY	INPUT VOLTAGE	DIMMING	CRI	DISTRIBUTION PATTERN	PHOTOCELL INCLUDED	HOUSING COLOR	LEGACY EQUIVALENT
KT-ALED290PS-L2-OSB-PMA-8CSB-VDIM-P-W	290W	3000K	36320	125 lm/W	120-277V	0-10V	>80	Type III installed, Types IV and V included	Yes	White	1000W MH
		4000K	42770	147 lm/W							
		5000K	38700	133 lm/W							
	210W	3000K	27300	130 lm/W							
		4000K	31710	151 lm/W							
		5000K	28980	138 lm/W							
	185W	3000K	22970	124 lm/W							
		4000K	27060	146 lm/W							
		5000K	24440	132 lm/W							
KT-ALED290PS-L2-OSB-SF-8CSB-VDIM-P	290W	3000K	36320	125 lm/W	120-277V	0-10V	>80	Type III installed, Types IV and V included	Yes	Bronze	1000W MH
		4000K	42770	147 lm/W							
		5000K	38700	133 lm/W							
	210W	3000K	27300	130 lm/W							
		4000K	31710	151 lm/W							
		5000K	28980	138 lm/W							
	185W	3000K	22970	124 lm/W							
		4000K	27060	146 lm/W							
		5000K	24440	132 lm/W							
KT-ALED290PS-L2-OSB-SF-8CSB-VDIM-P-W	290W	3000K	36320	125 lm/W	120-277V	0-10V	>80	Type III installed, Types IV and V included	Yes	White	1000W MH
		4000K	42770	147 lm/W							
		5000K	38700	133 lm/W							
	210W	3000K	27300	130 lm/W							
		4000K	31710	151 lm/W							
		5000K	28980	138 lm/W							
	185W	3000K	22970	124 lm/W							
		4000K	27060	146 lm/W							
		5000K	24440	132 lm/W							



120-277V | Dedicated

CATALOG NUMBER	WATTAGE	CCT	LUMENS	EFFICACY	INPUT VOLTAGE	DIMMING	CRI	DISTRIBUTION PATTERN	PHOTOCELL INCLUDED	HOUSING COLOR	LEGACY EQUIVALENT
KT-ALED70-S2-OSA-NM-840-VDIM	70W	4000K	10810	154 lm/W	120-277V	0-10V	>80	Type III Installed, Type V Included	No	Bronze	250W MH
KT-ALED70-S2-OSA-NM-850-VDIM		5000K									
KT-ALED100-S2-OSA-NM-840-VDIM	100W	4000K	14850	149 lm/W	120-277V	0-10V	>80	Type III Installed, Type V Included	No	Bronze	320W MH
KT-ALED100-S2-OSA-NM-850-VDIM		5000K									
KT-ALED140-M2-OSA-NM-840-VDIM	140W	4000K	20920	149 lm/W	120-277V	0-10V	>80	Type III Installed, Type V Included	No	Bronze	400W MH
KT-ALED140-M2-OSA-NM-850-VDIM		5000K									
KT-ALED210-L2-OSA-NM-840-VDIM	210W	4000K	31710	151 lm/W	120-277V	0-10V	>80	Type III Installed, Type V Included	No	Bronze	750W MH
KT-ALED210-L2-OSA-NM-850-VDIM		5000K									
KT-ALED290-L2-OSA-NM-840-VDIM	290W	4000K	42420	146 lm/W	120-277V	0-10V	>80	Type III Installed, Type V Included	No	Bronze	1000W MH
KT-ALED290-L2-OSA-NM-850-VDIM		5000K									

120-277V | Power and Color Select

CATALOG NUMBER	SELECTABLE WATTAGE	SELECTABLE CCT	LUMENS	EFFICACY	INPUT VOLTAGE	DIMMING	CRI	DISTRIBUTION PATTERN	PHOTOCELL INCLUDED	HOUSING COLOR	LEGACY EQUIVALENT
KT-ALED140PS-M2-OSA-NM-8CSB-VDIM-B	140W	3000K	17950	128 lm/W	120-277V	0-10V	>80	Type III installed, Type V included	No	Black	400W MH
		4000K	20780	148 lm/W							
		5000K	19020	136 lm/W							
	100W	3000K	12720	127 lm/W							
		4000K	14750	148 lm/W							
		5000K	13530	135 lm/W							
KT-ALED140PS-M2-OSA-NM-8CSB-VDIM-S	140W	3000K	9310	133 lm/W	120-277V	0-10V	>80	Type III installed, Type V included	No	Silver	400W MH
		4000K	10740	153 lm/W							
		5000K	9880	141 lm/W							
	100W	3000K	17950	128 lm/W							
		4000K	20780	148 lm/W							
		5000K	19020	136 lm/W							
KT-ALED290PS-L2-OSA-NM-8CSB-VDIM-B	290W	3000K	12720	127 lm/W	120-277V	0-10V	>80	Type III installed, Type V included	No	Black	1000W MH
		4000K	14750	148 lm/W							
		5000K	13530	135 lm/W							
	210W	3000K	9310	133 lm/W							
		4000K	10740	153 lm/W							
		5000K	9880	141 lm/W							
KT-ALED290PS-L2-OSA-NM-8CSB-VDIM-S	290W	3000K	36320	125 lm/W	120-277V	0-10V	>80	Type III installed, Type V included	No	Black	1000W MH
		4000K	42770	147 lm/W							
		5000K	38700	133 lm/W							
	210W	3000K	27300	130 lm/W							
		4000K	31710	151 lm/W							
		5000K	28980	138 lm/W							
KT-ALED290PS-L2-OSA-NM-8CSB-VDIM-S	185W	3000K	22970	124 lm/W	120-277V	0-10V	>80	Type III installed, Type V included	No	Silver	1000W MH
		4000K	27060	146 lm/W							
		5000K	24440	132 lm/W							
	290W	3000K	36320	125 lm/W							
		4000K	42770	147 lm/W							
		5000K	38700	133 lm/W							
KT-ALED290PS-L2-OSA-NM-8CSB-VDIM-S	210W	3000K	27300	130 lm/W	120-277V	0-10V	>80	Type III installed, Type V included	No	Silver	1000W MH
		4000K	31710	151 lm/W							
		5000K	28980	138 lm/W							
	185W	3000K	22970	124 lm/W							
		4000K	27060	146 lm/W							
		5000K	24440	132 lm/W							

Continued on next page



277-480V | Power and Color Select

CATALOG NUMBER	SELECTABLE WATTAGE	SELECTABLE CCT	LUMENS	EFFICACY	INPUT VOLTAGE	DIMMING	CRI	DISTRIBUTION PATTERN	PHOTOCELL INCLUDED	HOUSING COLOR	LEGACY EQUIVALENT
KT-ALED140PSHV-M2-OSA-NM-8CSB-VDIM	140W	3000K	17950	128 lm/W	277-480V	0-10V	>80	Type III installed, Type V included	No	Bronze	400W MH
		4000K	20780	148 lm/W							
		5000K	19020	136 lm/W							
	100W	3000K	12720	127 lm/W							
		4000K	14750	148 lm/W							
		5000K	13530	135 lm/W							
	70W	3000K	9310	133 lm/W							
		4000K	10740	153 lm/W							
		5000K	9880	141 lm/W							
KT-ALED290PSHV-L2-OSA-NM-8CSB-VDIM	290W	3000K	36320	125 lm/W	277-480V	0-10V	>80	Type III installed, Type V included	No	Bronze	1000W MH
		4000K	42770	147 lm/W							
		5000K	38700	133 lm/W							
	210W	3000K	27300	130 lm/W							
		4000K	31710	151 lm/W							
		5000K	28980	138 lm/W							
	185W	3000K	22970	124 lm/W							
		4000K	27060	146 lm/W							
		5000K	24440	132 lm/W							

Performance Accessories | Area Light with OpticSwap

CATALOG NUMBER	DESCRIPTION
KT-ALED-GS-S2-KIT	Reversible glare shield for small size housing; Series 2 Area Lights
KT-ALED-GS-M2-KIT	Reversible glare shield for medium size housing; Series 2 Area Lights
KT-ALED-GS-L2-KIT	Reversible glare shield for large size housing; Series 2 Area Lights



Optic Lens Kits | Area Light with OpticSwap

CATALOG NUMBER	DESCRIPTION
KT-ALED-LENS-L2-2-KIT	Type II optics lens for CCT Dedicated, large size housing, Series 2 Area Lights
KT-ALED-LENS-L2-2CS-KIT	Type II optics lens for Color Select, large size housing, Series 2 Area Lights
KT-ALED-LENS-L2-3-KIT	Type III optics lens for CCT Dedicated, large size housing, Series 2 Area Lights
KT-ALED-LENS-L2-3CS-KIT	Type III optics lens for Color Select, large size housing, Series 2 Area Lights
KT-ALED-LENS-L2-4-KIT	Type IV optics lens for CCT Dedicated, large size housing, Series 2 Area Lights
KT-ALED-LENS-L2-4CS-KIT	Type IV optics lens for Color Select, large size housing, Series 2 Area Lights
KT-ALED-LENS-L2-5-KIT	Type V optics lens for CCT Dedicated, large size housing, Series 2 Area Lights
KT-ALED-LENS-L2-5CS-KIT	Type V optics lens for Color Select, large size housing, Series 2 Area Lights
KT-ALED-LENS-M2-2-KIT	Type II optics lens for CCT Dedicated, medium size housing, Series 2 Area Lights
KT-ALED-LENS-M2-2CS-KIT	Type II optics lens for Color Select, medium size housing, Series 2 Area Lights
KT-ALED-LENS-M2-3-KIT	Type III optics lens for CCT Dedicated, medium size housing, Series 2 Area Lights
KT-ALED-LENS-M2-3CS-KIT	Type III optics lens for Color Select, medium size housing, Series 2 Area Lights
KT-ALED-LENS-M2-4-KIT	Type IV optics lens for CCT Dedicated, medium size housing, Series 2 Area Lights
KT-ALED-LENS-M2-4CS-KIT	Type IV optics lens for Color Select, medium size housing, Series 2 Area Lights
KT-ALED-LENS-M2-5-KIT	Type V optics lens for CCT Dedicated, medium size housing, Series 2 Area Lights
KT-ALED-LENS-M2-5CS-KIT	Type V optics lens for Color Select, medium size housing, Series 2 Area Lights
KT-ALED-LENS-S2-2-KIT	Type II optics lens for CCT Dedicated, small size housing, Series 2 Area Lights
KT-ALED-LENS-S2-3-KIT	Type III optics lens for CCT Dedicated, small size housing, Series 2 Area Lights
KT-ALED-LENS-S2-4-KIT	Type IV optics lens for CCT Dedicated, small size housing, Series 2 Area Lights
KT-ALED-LENS-S2-5-KIT	Type V optics lens for CCT Dedicated, small size housing, Series 2 Area Lights

Area Lights | Accessories



Mounting Kits | All

CATALOG NUMBER	DESCRIPTION	HOUSING COLOR	
KT-ALED-PM-1-KIT	Fixed pole mount kit, suitable for round or square poles	Bronze	
KT-ALED-PM-1-KIT-W	Fixed pole mount kit, suitable for round or square poles	White	
KT-ALED-PMA-1-KIT	Adjustable pole mount kit, suitable for round or square poles	Bronze	
KT-ALED-PMA-1-KIT-W	Adjustable pole mount kit, suitable for round or square poles	White	
KT-ALED-PMA-1-KIT-B	Adjustable pole mount kit, suitable for round or square poles	Black	
KT-ALED-PMA-1-KIT-S	Adjustable pole mount kit, suitable for round or square poles	Silver	
KT-ALED-SF-1-KIT	Slipfitter mount kit, fits 2 3/8" tenon	Bronze	
KT-ALED-SF-1-KIT-W	Slipfitter mount kit, fits 2 3/8" tenon	White	
KT-ALED-SF-1-KIT-B	Slipfitter mount kit, fits 2 3/8" tenon	Black	
KT-ALED-SF-1-KIT-S	Slipfitter mount kit, fits 2 3/8" tenon	Silver	
KT-ALED-TM-1-KIT	Trunnion mount kit	Bronze	
KT-ALED-TM-1-KIT-W	Trunnion mount kit	White	

Area Lights | Accessories



Performance Accessories | All

CATALOG NUMBER	DESCRIPTION	
KTSP-10KV-C	10kV surge protector, compact design	

Control Accessories | All

CATALOG NUMBER	DESCRIPTION	
KT-TLP-UV-3PN	NEMA 3-pin photocell 120-277V, 1800VA max, blue housing	
KT-TLP-HV-3PN	NEMA 3-pin photocell 200-480V, 1800VA max, yellow housing	
KT-RSC-7PN	NEMA 7-pin receptacle and shorting cap, black housing	

Sensors and Controls | All

CATALOG NUMBER	DESCRIPTION	
KTS-PIR3-12V-PKO /G2	Screw-in PIR sensor, preset for 10 min hold time, infinite standby time at 50% dim, daylight disabled	
KTS-MW3-12V-PKO /A	Screw-in microwave sensor, preset for 1 min hold time, 3 min standby time at 30% dim, daylight disabled	
KTS-MW3-12V-PKO /B	Screw-in microwave sensor, preset for 5 min hold time, 10 min standby time at 10% dim, daylight disabled	
KTS-MW3-REMOTECONTROL	KTS-MW3-12V-PKO and KTS-PIR3-12V-PKO sensors (all revisions and versions)	
KTSL-FC3-12V-PKO-PIR	Bluetooth mesh screw-in PIR occupancy sensor with built-in fixture controller for SmartLoop system	
KTSL-FC4-12V-PKO	Bluetooth mesh screw-in fixture controller for SmartLoop system	



Poles

CATALOG NUMBER	DESCRIPTION	
KT-SP-4SQ-15-11G-UNV	4 in square steel pole, 15 ft, 11 GA, universal drill pattern on all 4 sides. Includes pole, pole cap, base plate cover, handhold cover, and plugs for the universal drill pattern	
KT-SP-4SQ-20-11G-UNV	4 in square steel pole, 20 ft, 11 GA, universal drill pattern on all 4 sides. Includes pole, pole cap, base plate cover, handhold cover, and plugs for the universal drill pattern	
KT-SP-4SQ-25-11G-UNV	4 in square steel pole, 25 ft, 11 GA, universal drill pattern on all 4 sides. Includes pole, pole cap, base plate cover, handhold cover, and plugs for the universal drill pattern	
KT-SP-5SQ-30-7G-UNV	5 in square steel pole, 30 ft, 7 GA, universal drill pattern on all 4 sides. Includes pole, pole cap, base plate cover, handhold cover, and plugs for the universal drill pattern	

Anchor Bolt Kits

CATALOG NUMBER	DESCRIPTION	
KT-ABOLT-4SQ-K1	Anchor bolt kit for 4" square poles. (4) 3/4 in x 30 in bolts and hardware. Includes template	
KT-ABOLT-5SQ-K1	Anchor bolt kit for 5" square poles. (4) 1 in x 36 in Bolts and hardware. Includes template	

Poles and anchor bolts ship separately. To ship together, add -K1 to end of Pole catalog number

Wall Mount Tenon Adapters for Slipfitter Fixture Mount | All

CATALOG NUMBER	DESCRIPTION	
KT-WMT-S	Wall mount single 2 3/8" tenon, bronze housing	
KT-WMT-S90	Wall mount single 2 3/8" tenon, 90°, bronze housing	

Pole Mount Side Tenon Adapters for Slipfitter Fixture Mount | All

CATALOG NUMBER	DESCRIPTION	
KT-PMST-SQ-S	Pole mount single 2 3/8" tenon, side mount for square pole, bronze housing	
KT-PMST-R-S	Pole mount single 2 3/8" tenon, side mount for round pole, bronze housing	



Pole Mount Top Tenon Adapters for Slipfitter Fixture Mount | All

CATALOG NUMBER	DESCRIPTION	
KT-PMTT-4R-SV	Pole mount single 2 3/8" tenon, top mount vertical for 4" round pole, bronze housing	
KT-PMTT-4SQ-SV	Pole mount single 2 3/8" tenon, top mount vertical for 4" square pole, bronze housing	
KT-PMTT-5SQ-SV	Pole mount single 2 3/8" tenon, top mount vertical for 5" square pole, bronze housing	
KT-PMTT-4SQ-S90	Pole mount single 2 3/8" tenon, top mount horizontal 90° for 4" square pole, bronze housing	

Pole Mount Top Tenon Adapters for Slipfitter Fixture Mount | All

CATALOG NUMBER	DESCRIPTION	
KT-PMTT-4SQ-D180	Pole mount dual 2 3/8" tenon, top mount horizontal 180° for 4" square pole, bronze housing	
KT-PMTT-4SQ-D90	Pole mount dual 2 3/8" tenon, top mount horizontal 90° for 4" square pole, bronze housing	
KT-PMTT-4SQ-T90	Pole mount triple 2 3/8" tenon, top mount horizontal 90° for 4" square pole, bronze housing	
KT-PMTT-4SQ-Q90	Pole mount quad 2 3/8" tenon, top mount horizontal 90° for 4" square pole, bronze housing	

Bullhorn Adapters for Slipfitter Fixture Mount | All

CATALOG NUMBER	DESCRIPTION	
KT-BH-SF-D180	Dual bullhorn, in-line 180°, slips over 2 3/8" tenon	
KT-BH-SF-T180	Triple bullhorn, in-line 180°, slips over 2 3/8" tenon	
KT-BH-SF-T120	Triple bullhorn, 120°, slips over 2 3/8" tenon	
KT-BH-SF-Q180	Quad bullhorn, in-line 180°, slips over 2 3/8" tenon	
KT-BH-SF-Q90	Quad bullhorn, 90°, slips over 2 3/8" tenon	

Dusk-to-Dawn Fixture | Area Lights



Power and Color Select

CATALOG NUMBER	SELECTABLE WATTAGE	SELECTABLE CCT	LUMENS	EFFICACY	INPUT VOLTAGE	HOUSING COLOR	DISTRIBUTION	DLC	MOUNTING INCLUDED	CRI	METAL HALIDE EQUIVALENT
KT-ALED60PS-D2D-WM-8CSB-VDIM	60W	3000K	9000	150 lm/w	120-277V	Gray	V	Yes	No	>80	150-250W MH
		4000K	9250	154 lm/w							
		5000K	9120	152 lm/w							
	40W	3000K	6640	166 lm/w							
		4000K	6850	171 lm/w							
		5000K	6720	168 lm/w							
	30W	3000K	5010	167 lm/w							
		4000K	5200	173 lm/w							
		5000K	5100	170 lm/w							

Standard

CATALOG NUMBER	WATTAGE	CCT	LUMENS	EFFICACY	INPUT VOLTAGE	HOUSING COLOR	DISTRIBUTION	DLC	CRI	METAL HALIDE EQUIVALENT
KT-ALED40-D2D-WM-850-VDIM	40W	5000K	6150	155 lm/W	120-277V	Gray	V	Yes	>80	175W MH

Mounts and Brackets

CATALOG NUMBER	DESCRIPTION	
KT-ALED-CA-D2D-KIT	24" curved arm mounting pole, for dusk-to-dawn area light, gray	



Complimentary Lighting Layouts

As a maker of a wide variety of outdoor lighting products, Keystone knows how valuable providing solutions for lighting design can be.

That's why we can provide answers to your lighting questions to determine how many fixtures you need, what types of lamps are best for your applications, and how to save the maximum amount of energy, all within budget.

By utilizing industry-leading lighting layout design software, we provide accurate and dependable application renderings. For new constructions or retrofit, simply provide Keystone with a few key project details, and our lighting designers will get to work on your request.



Visit: keystonetech.com/lighting-layout



LIT-BR-OUTDOOR-FIX

SINCE 1945
KEYSTONE
LIGHT MADE EASY®

Keystone Technologies Philadelphia, PA 800.464.2680 kestonetech.com
LAMPS | FIXTURES | POWER SUPPLIES | CONTROLS