

AL-LED-L1-X-290HV-8XX-NM

LED AREA LIGHT FIXTURES



Compact 290W High-Performance LED Area Light,
High-Voltage, 277–480V Input, Bronze Housing,
Multiple Mounting, Optics, and Control options

PRODUCT FEATURES

- Compact, low-profile design delivers high-performance illumination and improves application site aesthetics
- Heavy-duty, die-cast aluminum housing with ample heat sinking for enhanced thermal performance
- True U0 design for Dark Sky compliant performance eliminates undesirable sky glow
- Integrated NEMA/ANSI C136.10 3-pin twist-lock receptacle with shorting cap, standard on all fixtures, simplifies ordering requirements for photo control needs
- Precision-crafted optics, available with type II, III, IV, and V patterns, to meet diverse requirements from general purpose to specification-grade applications
- Integral latch design for hassle-free, hinged access to driver compartment
- Four contractor-friendly mounting options available (sold separately): slip fitter mount, adjustable pole mount for square and round poles, fixed pole mount for square and round poles, and trunnion mount
- Bi-level occupancy sensors and twist-lock photocell accessories available
- Reversible glare shield available, suitable for backside (house-side) or frontside (street-side) shielding
- Powered by 0–10V dimming LED driver featuring 12V AUX power tap, 6kV surge protection
- Ambient operating temperature: –40°C/–40°F to 50°C/122°F
- UL Certified for wet locations, IP65
- 0–10V dimming, 10% min
- Power factor: >0.95
- THD: <20%
- LED chip lifetime: L70 >100,000 hrs @ 25°C/77°F ambient fixture temp
- Meets FCC Part 15, Part B, Class A standards for conducted and radiated emissions



ELECTRICAL SPECIFICATIONS

Catalog Number	Wattage	Lumens	Efficacy	Dimming	Color Temp	CRI	Dist Type*	Input Voltage	Rated Life	Legacy Equivalent	Housing Color**	Additional Features
AL-LED-L1-3-290HV-840-NM	290W	40,310 lm	139 lm/W	0–10V	4000K	>80	III	277–480V	50,000 hrs	1000W	Bronze	10kV external surge protection included Automatic power disconnect on fixture access door
AL-LED-L1-3-290HV-850-NM		40,890 lm	141 lm/W		5000K		III					
AL-LED-L1-5-290HV-840-NM		40,600 lm	140 lm/W		4000K		V					
AL-LED-L1-5-290HV-850-NM		41,180 lm	142 lm/W		5000K		V					

* Fixtures with Type 2 (II) and Type 4 (IV) optics are available and assembled to order. Lead times may apply. Please see catalog number breakdown for full ordering code details.

** Fixtures (and mounts) with alternate housing colors are available and made to order. Extended lead times apply. Please see catalog number breakdown for full ordering code details.

AL-LED-L1-X-290HV-8XX-NM

LED AREA LIGHT FIXTURES

MOUNTING BRACKET OPTIONS (SOLD SEPARATELY)

SLIP FITTER MOUNT

Fits 2 3/8" tennon; Bronze

Catalog Number	UPC	Easy Code
KT-ALED-SF-1-KIT	843654131641	JRH-74



ADJUSTABLE POLE MOUNT

For round or square pole; Bronze

Catalog Number	UPC	Easy Code
KT-ALED-PMA-1-KIT	843654131634	DAQ-87



FIXED POLE MOUNT

For round or square pole; Bronze

Catalog Number	UPC	Easy Code
KT-ALED-PM-1-KIT	843654131627	QVG-29



TRUNNION MOUNT

Bronze

Catalog Number	UPC	Easy Code
KT-ALED-TM-1-KIT	843654131658	GTH-37

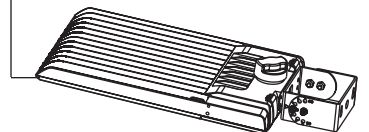
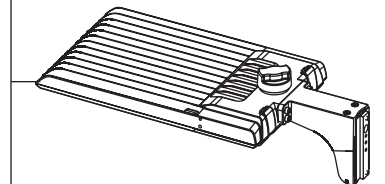
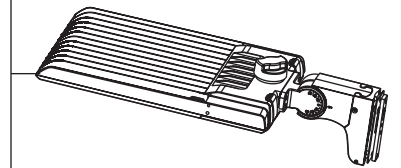
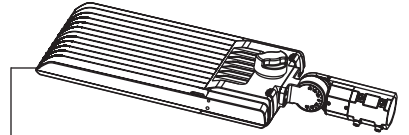
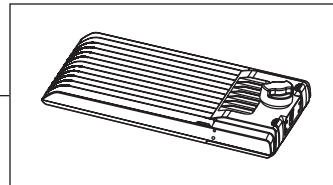

AL-LED-L1-X-290HV-8XX-NM

LED AREA LIGHT FIXTURES

PHYSICAL SPECIFICATIONS

LED AREA LIGHT FIXTURE

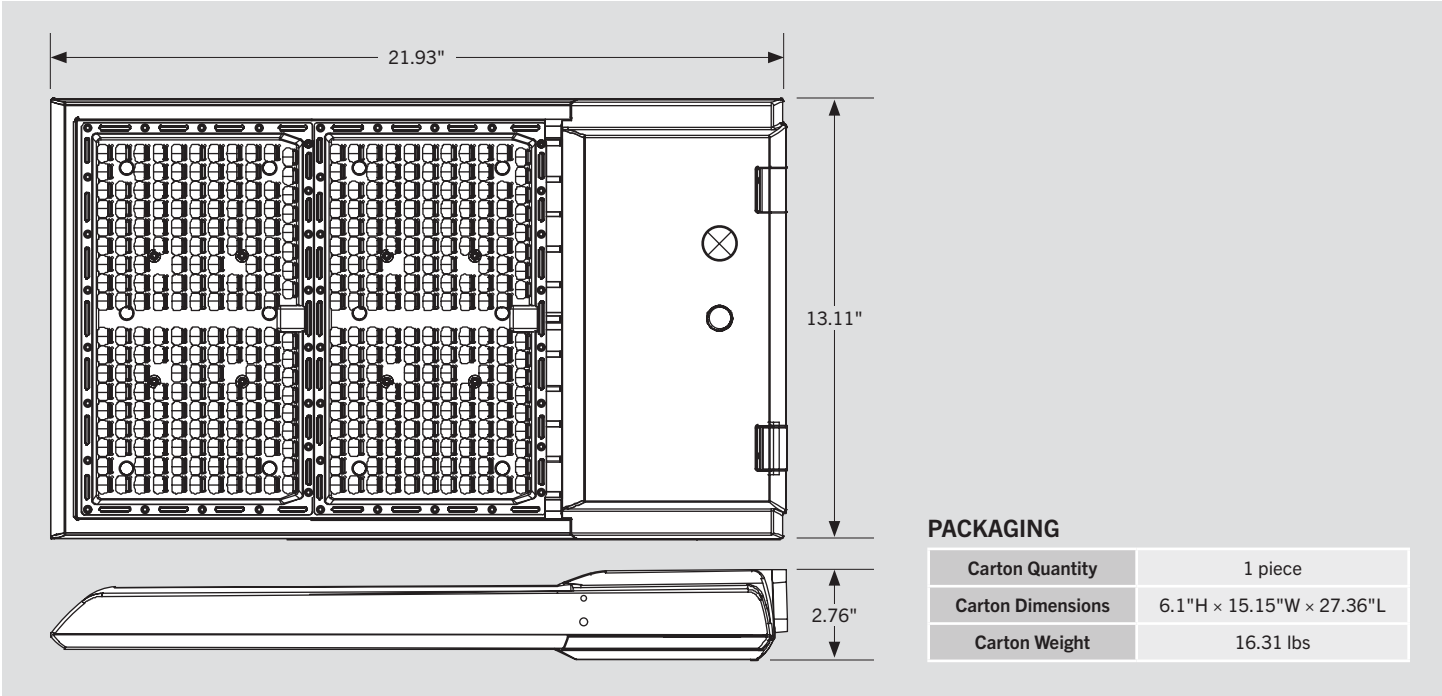

POLE MOUNT (ADJUSTABLE OR FIXED) DRILLING HOLES

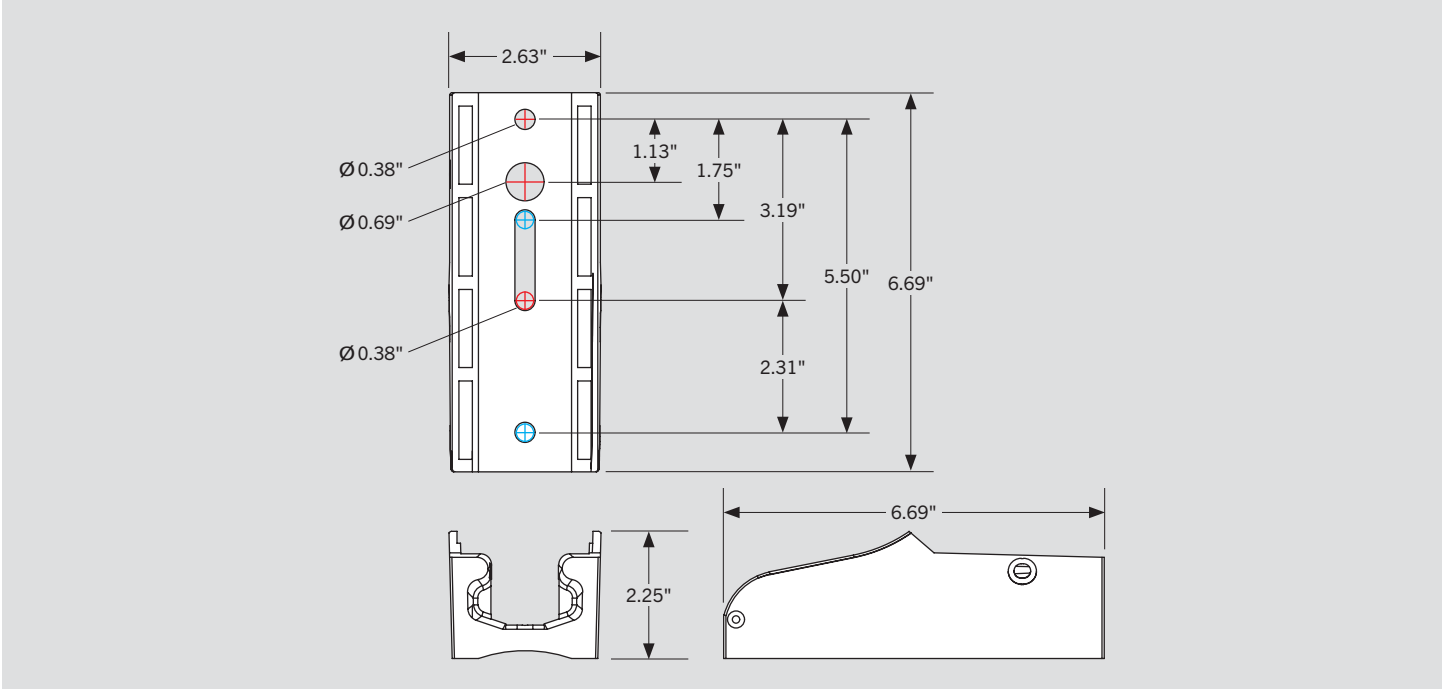

AL-LED-L1-X-290HV-8XX-NM

LED AREA LIGHT FIXTURES

WIRING DIAGRAM

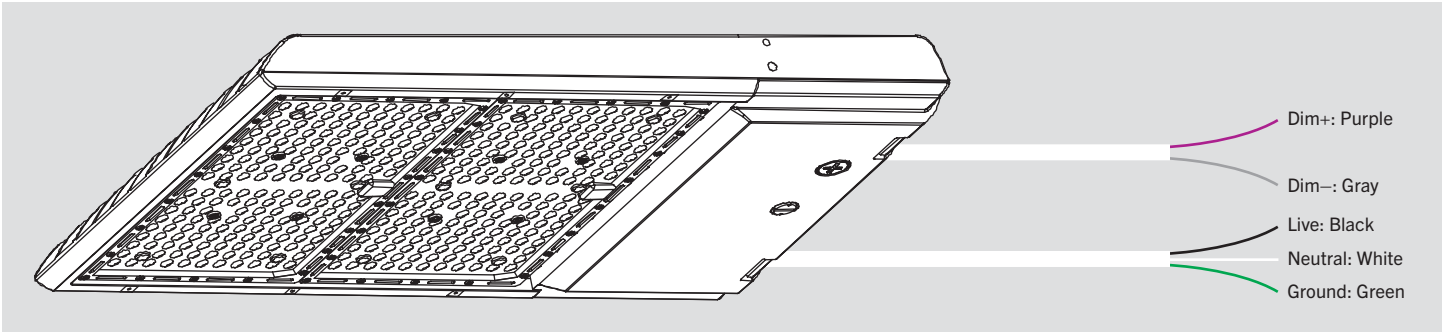

LIGHT DISTRIBUTION PATTERN

TYPE 3 (III)

Pole-mount view from above; Area light mounted at 35'

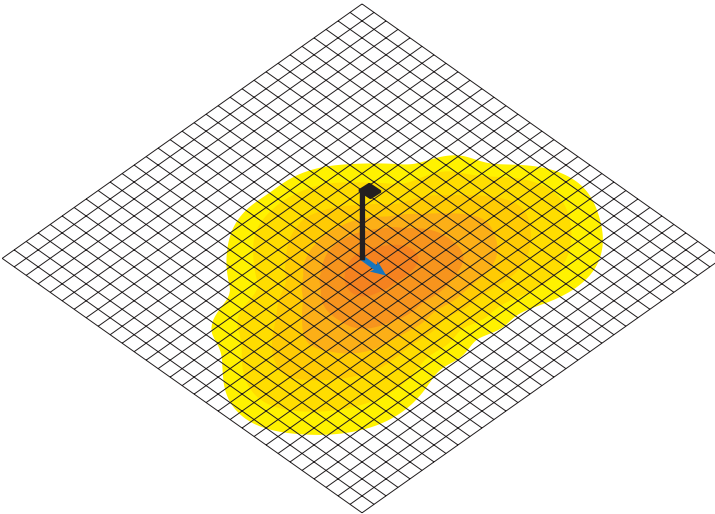

- Photometric layout for general reference only
- Grid dimension: 10 × 10 sq ft

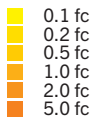

TYPE 5 (V)

Pole-mount view from above; Area light mounted at 35'

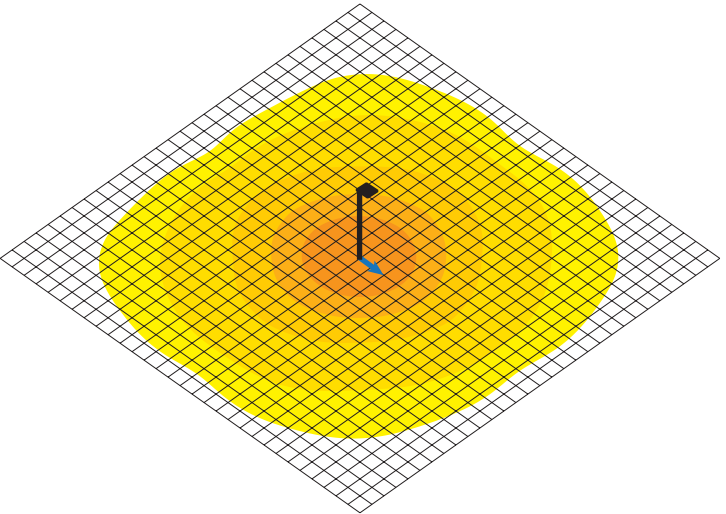

- Photometric layout for general reference only
- Grid dimension: 10 × 10 sq ft

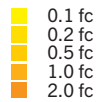

AL-LED-L1-X-290HV-8XX-NM

LED AREA LIGHT FIXTURES

PHOTOMETRIC SPECIFICATIONS (TYPE 3 [III])

ISOCANDELA PLOT

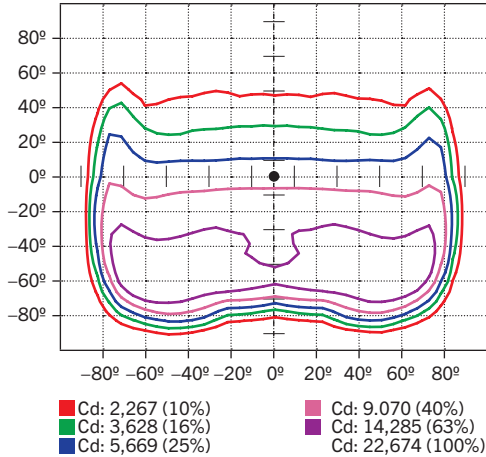

LUMINOUS INTENSITY DISTRIBUTION

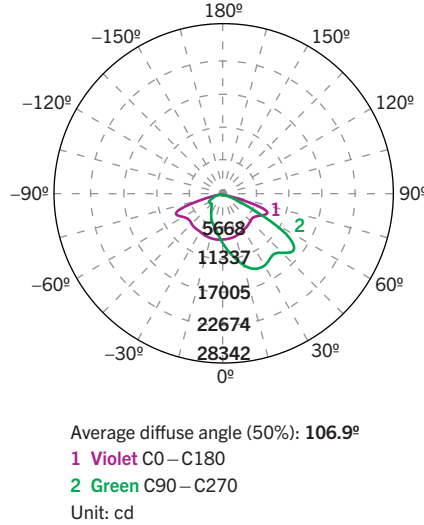

FLUX DISTRIBUTION

Zone	Lumens	% Luminaire
Forward Light	32,314 lm	79.9%
0°–30°	4,530 lm	11.2%
30°–60°	15,899 lm	39.3%
60°–80°	11,196 lm	27.7%
80°–90°	689 lm	1.7%
Back Light	8,143 lm	20.1%
0°–30°	2,219 lm	5.5%
30°–60°	3,754 lm	9.3%
60°–80°	2,016 lm	5.0%
80°–90°	153 lm	0.4%
Up Light	0 lm	0.0%
90°–100°	0 lm	0.0%
100°–180°	0 lm	0.0%

BUG* Rating	
Asymmetrical Luminaire Types	
Type I, II, III, IV	B3 U0 G4
Quadrilateral Symmetrical Luminaire Types	
Type V, Area Light	B3 U0 G4

* Backlight, Uplight, Glare

PHOTOMETRIC SPECIFICATIONS (TYPE 5 [V])

ISOCANDELA PLOT

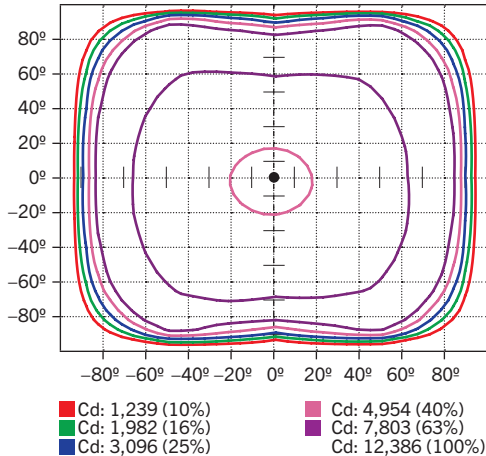

LUMINOUS INTENSITY DISTRIBUTION

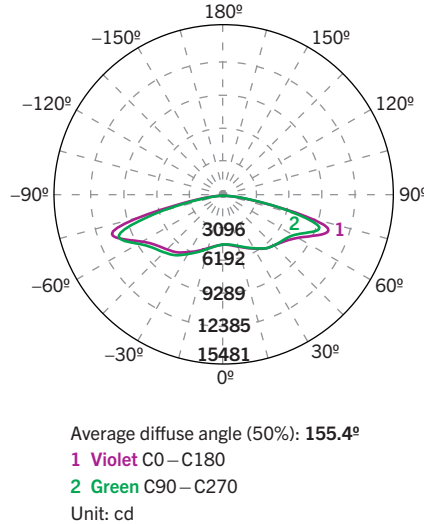

FLUX DISTRIBUTION

Zone	Lumens	% Luminaire
Forward Light	20,131 lm	49.0%
0°–30°	2,125 lm	5.2%
30°–60°	7,503 lm	18.3%
60°–80°	8,830 lm	21.5%
80°–90°	1,673 lm	4.1%
Back Light	20,962 lm	50.0%
0°–30°	2,229 lm	5.4%
30°–60°	8,163 lm	19.9%
60°–80°	9,389 lm	22.8%
80°–90°	1,182 lm	2.9%
Up Light	0 lm	0.0%
90°–100°	0 lm	0.0%
100°–180°	0 lm	0.0%

BUG* Rating	
Asymmetrical Luminaire Types	
Type I, II, III, IV	B5 U0 G5
Quadrilateral Symmetrical Luminaire Types	
Type V, Area Light	B5 U0 G5

* Backlight, Uplight, Glare

AL-LED-L1-X-290HV-8XX-NM

LED AREA LIGHT FIXTURES

PHOTOMETRIC SPECIFICATIONS (TYPE 4 [IV])

ISOCANDELA PLOT

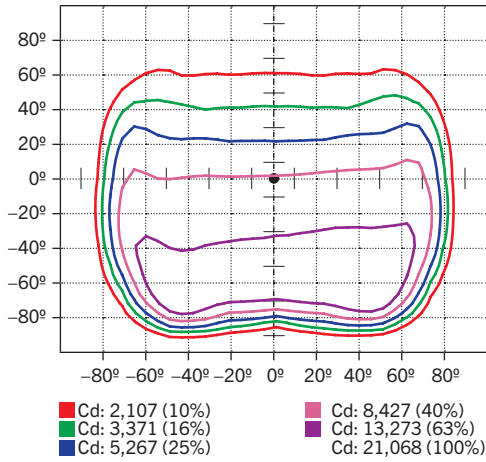

LUMINOUS INTENSITY DISTRIBUTION

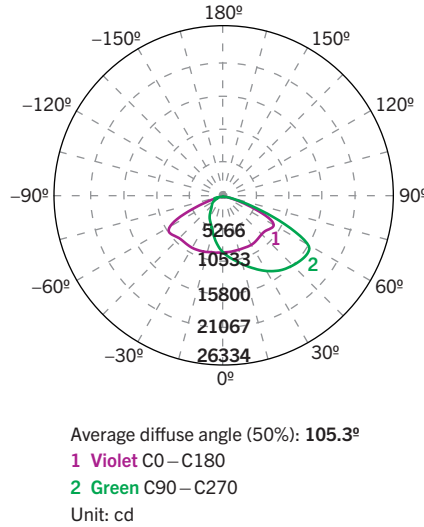

FLUX DISTRIBUTION

Zone	Lumens	% Luminaire
Forward Light	31,012 lm	75.6%
0°–30°	4,463 lm	10.9%
30°–60°	15,461 lm	37.7%
60°–80°	10,510 lm	25.6%
80°–90°	578 lm	1.4%
Back Light	10,008 lm	24.4%
0°–30°	2,733 lm	6.7%
30°–60°	4,949 lm	12.1%
60°–80°	2,097 lm	5.1%
80°–90°	229 lm	0.6%
Up Light	0 lm	0.0%
90°–100°	0 lm	0.0%
100°–180°	0 lm	0.0%

BUG* Rating	
Asymmetrical Luminaire Types	
Type I, II, III, IV	B4 U0 G4
Quadrilateral Symmetrical Luminaire Types	
Type V, Area Light	B4 U0 G4

* Backlight, Uplight, Glare

PHOTOMETRIC SPECIFICATIONS (TYPE 2 [II])

ISOCANDELA PLOT

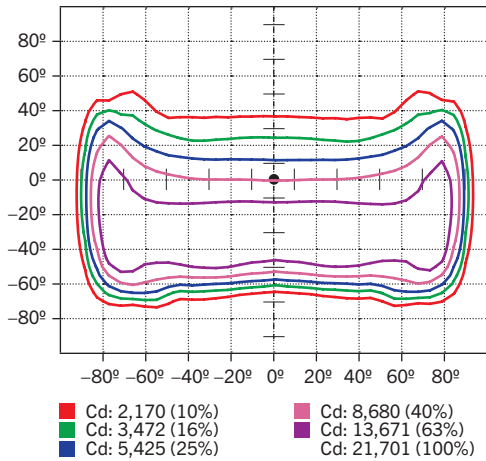

LUMINOUS INTENSITY DISTRIBUTION

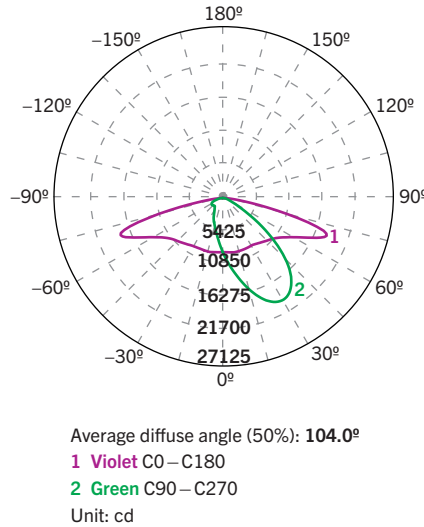

FLUX DISTRIBUTION

Zone	Lumens	% Luminaire
Forward Light	31,568 lm	77.5%
0°–30°	5,819 lm	14.3%
30°–60°	17,649 lm	43.3%
60°–80°	7,632 lm	18.7%
80°–90°	468 lm	1.1%
Back Light	9,181 lm	22.5%
0°–30°	2,337 lm	5.7%
30°–60°	3,918 lm	9.6%
60°–80°	2,720 lm	6.7%
80°–90°	206 lm	0.5%
Up Light	0 lm	0.0%
90°–100°	0 lm	0.0%
100°–180°	0 lm	0.0%

BUG* Rating	
Asymmetrical Luminaire Types	
Type I, II, III, IV	B4 U0 G4
Quadrilateral Symmetrical Luminaire Types	
Type V, Area Light	B4 U0 G4

* Backlight, Uplight, Glare















AL-LED-L1-X-290HV-8XX-NM

LED AREA LIGHT FIXTURES

EPA SPECIFICATIONS

Large-Size Fixture Housing

Conditions: Horizontal winds only for calculations. Worst case total projected area used for calculations. All drag coefficients are set as worst case 1.2. For details on exact EPA calculations and assumptions, please contact your sales representative.

EPA Calcs (1.2*ft ² View)		Single Fixture	2 Fixtures at 90°	2 Fixtures at 180°	3 Fixtures at 90°	3 Fixtures at 120°	4 Fixtures at 90°	2 Fixtures Side-by-Side	3 Fixtures Side-by-Side	4 Fixtures Side-by-Side
Mounting Application	Fixture Position									
Adjustable Pole Mount 	Horizontal	0.62 sq. ft.	0.90 sq. ft.	1.24 sq. ft.	1.42 sq. ft.	1.48 sq. ft.	1.42 sq. ft.	0.74 sq. ft.	1.11 sq. ft.	1.48 sq. ft.
Adjustable Pole Mount 	45°	1.85 sq. ft.	2.43 sq. ft.	1.85 sq. ft.	3.01 sq. ft.	4.42 sq. ft.	3.01 sq. ft.	3.70 sq. ft.	5.55 sq. ft.	7.40 sq. ft.
Slip Fitter Mount 	Horizontal	0.60 sq. ft.	0.98 sq. ft.	1.20 sq. ft.	1.53 sq. ft.	1.57 sq. ft.	1.53 sq. ft.	0.86 sq. ft.	1.30 sq. ft.	1.73 sq. ft.
Slip Fitter Mount 	45°	1.92 sq. ft.	2.51 sq. ft.	1.92 sq. ft.	3.09 sq. ft.	4.39 sq. ft.	3.09 sq. ft.	3.84 sq. ft.	5.76 sq. ft.	7.68 sq. ft.
Slip Fitter Mount 	Vertical	2.59 sq. ft.	3.19 sq. ft.	2.59 sq. ft.	3.80 sq. ft.	4.07 sq. ft.	3.80 sq. ft.	5.18 sq. ft.	7.77 sq. ft.	10.35 sq. ft.

ORDERING INFORMATION

ORDER CODE	PACK QTY.	UPC	Easy Code
AL-LED-L1-3-290HV-840-NM	1	843654135724	XME-29
AL-LED-L1-3-290HV-850-NM	1	843654135731	OAA-91
AL-LED-L1-5-290HV-840-NM	1	843654135748	VFG-98
AL-LED-L1-5-290HV-850-NM	1	843654135755	HKD-00