



KT-LED82P-V-8CSI-D

2-PIN LED CFL REPLACEMENT LAMP

DESCRIPTION

8.5W 2-Pin LED Lamp | Color Select 2700/4000/5000K | G24d Base |
Type B Line Voltage Compatible



LAMP TYPE: LED CFL Replacement
BULB TYPE: 2-Pin LED
BASE TYPE: G24d
WATTAGE: 8.5W
SELECTABLE COLOR TEMPERATURE: 2700/4000/5000K
COLOR RENDERING INDEX (CRI): ≥ 82
WARRANTY: 5 Years



PRODUCT FEATURES

- Replaces 13W, 18W, and 26W legacy lamps with G24q, GX24q, G24d, and GX24d bases
- G24d 2-pin bases can be used in G24Q 4-pin applications for ballast bypass
- Keystone Color Select technology (2700/4000/5000K)
- Approximately 50% more energy efficient vs legacy CFL lamps
- Up to 5x longer life vs traditional lamps
- Frosted diffuser that eliminates pixilation and glare
- Environmentally friendly. No mercury used
- Instant startup
- UL Classified Retrofit Kit
- Suitable for use in damp locations
- Not for use in enclosed luminaires
- Non dimmable
- 50,000 hour lifetime
- Operating temperature: -20°C/-4°F to 45°C/113°F
- Compliant with FCC Part 15 Class B

PERFORMANCE SPECIFICATIONS

Catalog Number	Wattage	Selectable CCT	Lumens	Efficacy	Input Voltage	CRI	Base Type	Beam Angle	Related Life
KT-LED82P-V-8CSI-D	8.5W	2700K	1000	118 lm/W	120-277V	≥ 82	G24d	110°	50,000 hrs
		4000K	1150	135 lm/W					
		5000K	1150	135 lm/W					

*Preset to 2700K



KT-LED82P-V-8CSI-D

2-PIN LED CFL REPLACEMENT LAMP

PHOTOMETRIC SPECIFICATIONS

POLAR CANDELA DISTRIBUTION

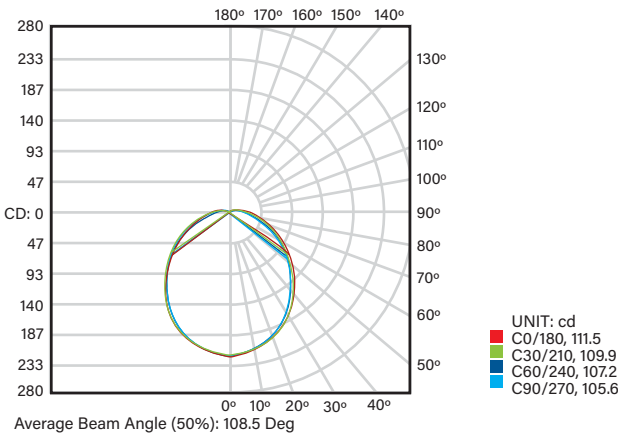

ILLUMINANCE PLOT

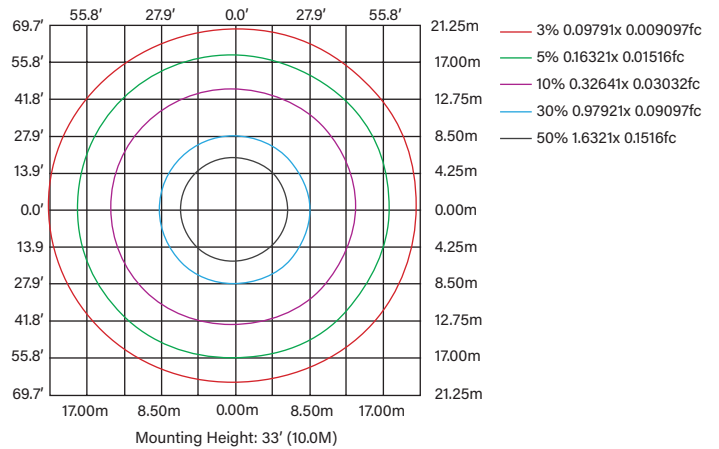

WIRING DIAGRAMS

BYPASS MAGNETIC BALLAST WITH 1 LAMP

BEFORE

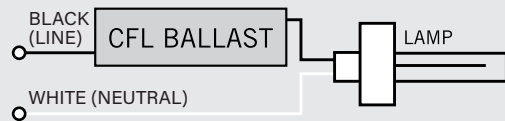

AFTER

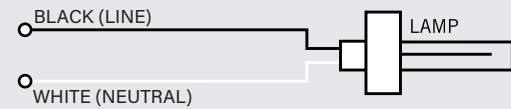

BYPASS ELECTRONIC BALLAST WITH 1 LAMP

BEFORE

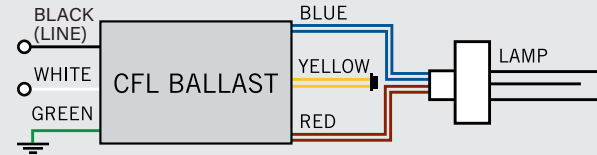

AFTER

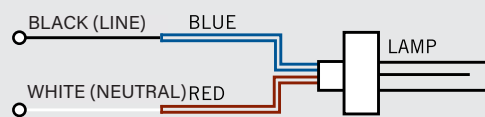

BYPASS MAGNETIC BALLAST WITH 2 LAMPS

BEFORE

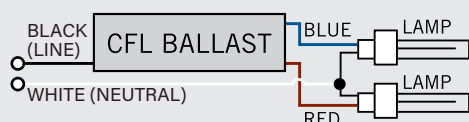

AFTER

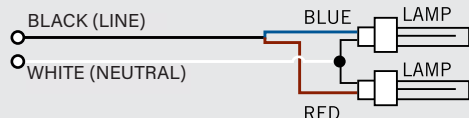

BYPASS ELECTRONIC BALLAST WITH 2 LAMPS

BEFORE

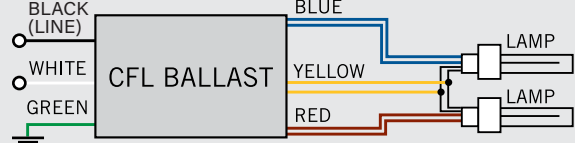

AFTER

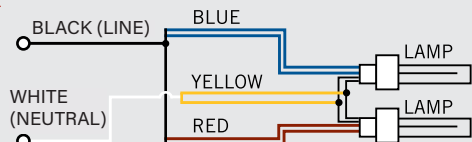



KT-LED82P-V-8CSI-D

2-PIN LED CFL REPLACEMENT LAMP

PHYSICAL SPECIFICATIONS

LAMP DIMENSIONS

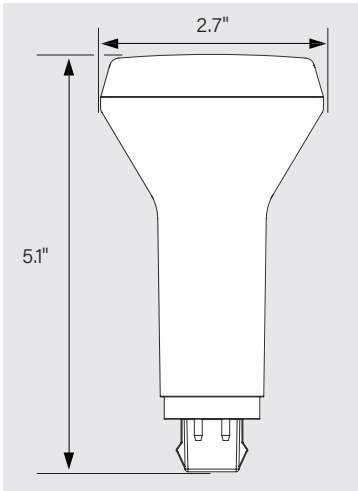

ORDERING INFORMATION

ORDER CODE	UPC	EASY CODE
KT-LED82P-V-8CSI-D	843654137704	RUQ-83

CATALOG NUMBER BREAKDOWN

KT-LED82P-V-8CSI-D

1 2 3 4 5 6 7 8 9

- 1 Keystone Technologies
- 2 LED Lamp
- 3 Wattage
- 4 2-Pin Lamp Type
- 5 Vertical Orientation
- 6 80 CRI
- 7 Color Select
- 8 Color Select Designation
- 9 Direct Drive Series

8 Color Select Designation

I	2700/4000/5000K
---	-----------------