

## KT-CLED40PS-S1-8CSB-VDIM

### LED CANOPY LIGHT FIXTURE

#### DESCRIPTION

General Purpose LED Canopy Light | Power Select 40/30/20W |  
Color Select 3000/4000/5000K | 120–277V Input | Bronze Housing

#### APPLICATION

Ceiling mounted outdoor illumination needs, such as parking garages, covered walkways, entrance areas, etc.



**10 YEAR**  
LIMITED WARRANTY



#### PRODUCT FEATURES

- Keystone Power Select technology (40/30/20W)
- Keystone Color Select technology (3000/4000/5000K)
- Familiar, low profile design ideal for a wide range of new and replacement installations
- Heavy-duty die-cast aluminum housing with a modern aesthetic and (3) 1/2" NPT threaded conduit hubs
- Suitable for standard junction box mounting or 3/4" NPT pendant mounting
- Built-in dusk-to-dawn photocell behind translucent 3/4" threaded plug with anti-yellowing agent
- Impact-resistant, polycarbonate diffuser with 160° parking garage distribution. Perfect for low mounting applications
- Optional 110° canopy distribution diffuser available. Perfect for high mounting applications
- Compatible with KTS-MW3-12V-PKO, quick install bi-level occupancy sensor accessory available
- Compatible with KTSL-FC4-12V-PKO, SmartLoop Bluetooth wireless controller accessory available
- Powered by Keystone LED 0–10V dimming driver
- Ambient operating temperature: –40°C/–40°F to 50°C/122°F
- UL certified for wet locations, IP65 rated
- Power Factor: > 0.95
- THD: < 20%
- L70 @ >100,000 hrs @ 25°C/77°F ambient fixture temperature
- Meets FCC Part 15, Part B, Class A standards for conducted and radiated emissions

#### PERFORMANCE SPECIFICATIONS

Catalog Number	Selectable Wattage	Selectable CCT	Lumens	Efficacy	Input Voltage	Dimming	CRI	Distribution Pattern	Photocell Included	Nominal Size	Housing Color	Legacy Equivalent
KT-CLED40PS-S1-8CSB-VDIM	40W	3000K	5000	125 lm/W	120–277V	0–10V	> 80	160°	Yes	8" square	Bronze	175W MH
		4000K	5600	140 lm/W								
		5000K	5200	130 lm/W								
	30W	3000K	3750	125 lm/W								
		4000K	4200	140 lm/W								
		5000K	3900	130 lm/W								
	20W	3000K	2500	125 lm/W								
		4000K	2800	140 lm/W								
		5000K	2600	130 lm/W								

Note: Preset to highest lumen output (40W/5000K)

Note: Color uniformity: CCT (Correlated Color Temperature) range as per guidelines outlined in ANSI C78.377-2017

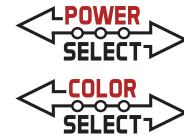

# KT-CLED40PS-S1-8CSB-VDIM

## LED CANOPY LIGHT FIXTURE

### PHOTOMETRIC SPECIFICATIONS

#### ISOCANDELA PLOT

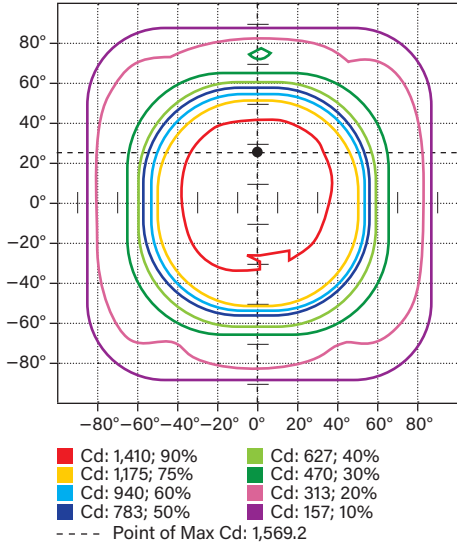

#### POLAR CANDELA DISTRIBUTION

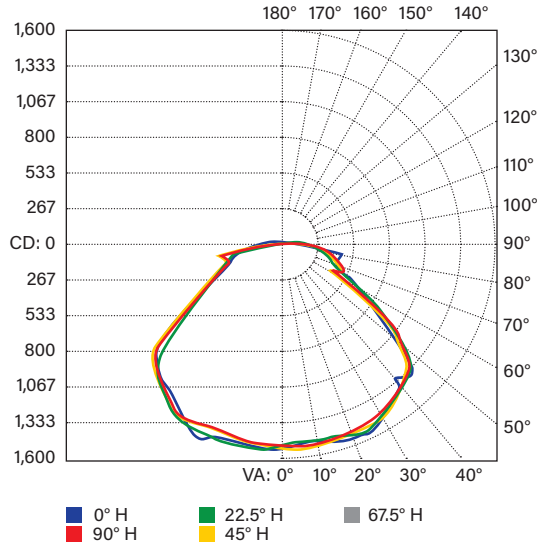

#### ZONAL LUMEN SUMMARY

Zone	Lumens	% Luminaire
0-30	1,238.1	23.2%
0-40	2,137.9	40.1%
0-60	3,992.1	74.9%
60-90	1,137.1	21.3%
70-100	702.5	13.2%
90-120	153.9	2.9%
0-90	5,129.2	96.2%
90-180	200.4	3.8%
0-180	5,329.6	100%

### POWER SELECT (WATTAGE) AND COLOR SELECT (CCT) ADJUSTMENT

This fixture is equipped with field-adjustable Keystone Power Select and Color Select technology.

1. Ensure power is off to the fixture.
2. Remove knockouts.
3. Adjust dip switches to desired settings.
4. Replace knockouts.
5. Restore power to fixture.

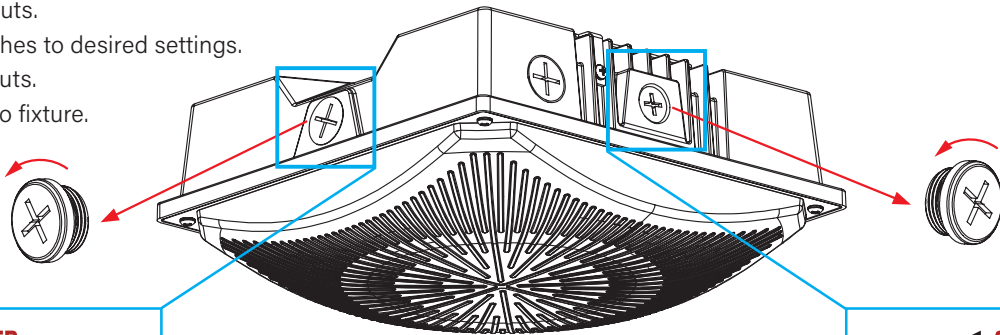

**POWER SELECT ADJUSTMENT SWITCH**  
Set dip switch to adjust wattage between 20W, 30W, and 40W. Fixture comes preset at 40W.



**COLOR SELECT ADJUSTMENT SWITCH**  
Set dip switch to adjust CCT between 3000K, 4000K, and 5000K. Fixture comes preset at 5000K.

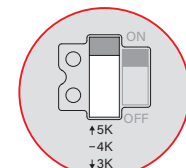

**PHOTOCELL ON/OFF SWITCH**  
Set dip switch to turn on or turn off built-in photocell.

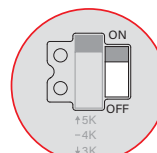

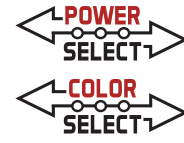

# KT-CLED40PS-S1-8CSB-VDIM

## LED CANOPY LIGHT FIXTURE

### DIMENSIONS

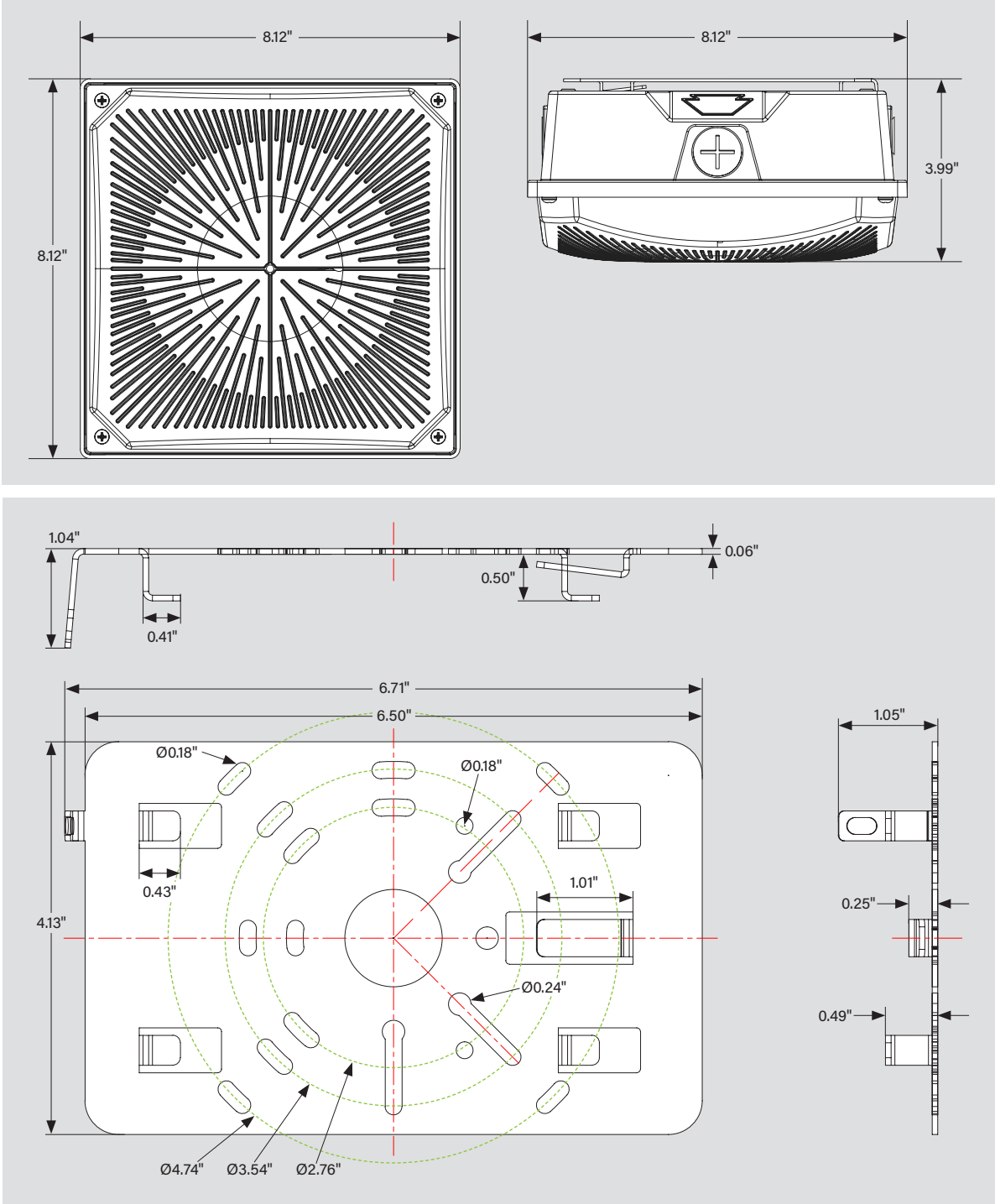

# KT-CLED40PS-S1-8CSB-VDIM

## LED CANOPY LIGHT FIXTURE

**WIRING DIAGRAMS**

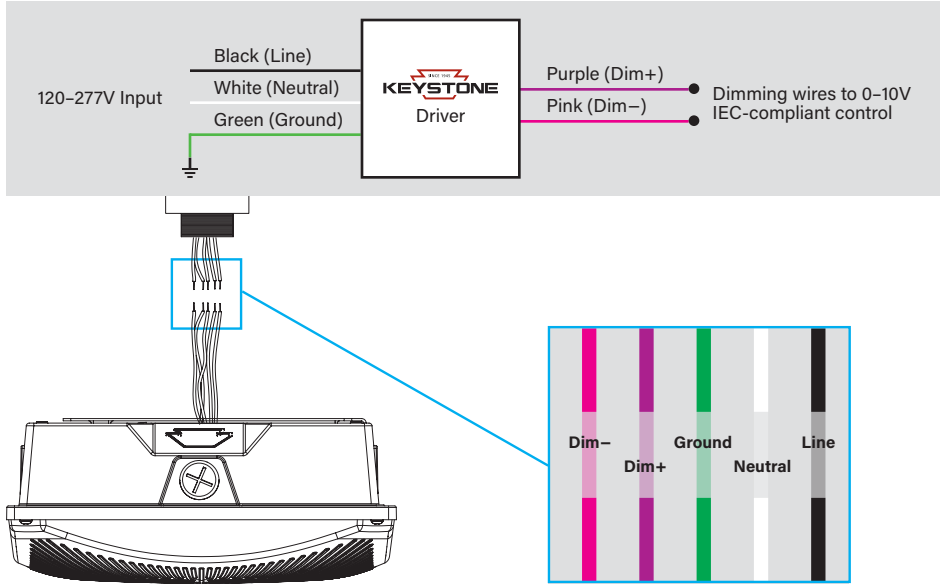

**ACCESSORIES**

**SENSORS / CONTROLLERS**

Factory-Installable OR Field-Installable (field-installable purchased separately)

✓	SUFFIX*	CATALOG NUMBER	DESCRIPTION	UPC	EASY CODE
	/FC4	KTSL-FC4-12V-PKO	Bluetooth mesh wireless screw-in low voltage fixture controller for SmartLoop system	843654149066	RUN-10
	/MW3	KTS-MW3-12V-PKO	12V Microwave Occupancy Sensor	843654135212	TRM-32



**LENSES**

Factory-Installable OR Field-Installable (field-installable purchased separately)

✓	SUFFIX*	CATALOG NUMBER	DESCRIPTION	UPC	EASY CODE
	/L110	KT-CLED-LENS-S1-110-KIT	110° beam angle lens   Used on 8" square canopy	843654152011	GNA-34

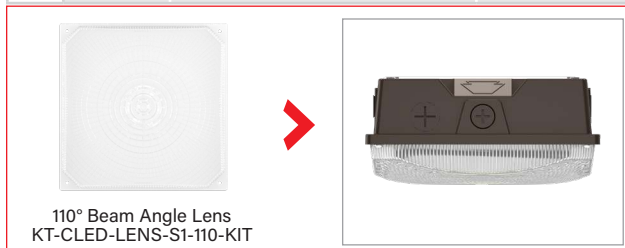

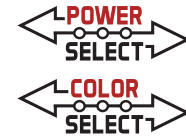

# KT-CLED40PS-S1-8CSB-VDIM

## LED CANOPY LIGHT FIXTURE

### MOUNTS AND BRACKETS

Field-Installable / Field-Use ONLY (purchased separately)

CATALOG NUMBER	DESCRIPTION	UPC	EASY CODE
KT-CLED-BP-15	15" mounting back plate   Bronze   Used on all canopy fixtures	843654152028	FHA-85
KT-CLED-SM-1-KIT	Surface mount / pendant mount kit   Bronze   Used on series 1 canopy fixtures   Attaches to pre-installed mounting plate	843654160368	HRA-27



\* For factory installation of accessory, add suffix to fixture part number (see ordering examples and instructions on last page of spec sheet).

### FIXTURE ORDERING INFORMATION

ORDER CODE	UPC	Easy Code	DLC PRODUCT ID
KT-CLED40PS-S1-8CSB-VDIM	843654151960	YFZ-10	S-217S3O
KT-CLED40PS-S1-8CSB-VDIM /L110	843654163123	AZK-33	S-7BTLCP S-ORPVJD

### FIXTURE CATALOG NUMBER BREAKDOWN

# KT-CLED40PS-S1-8CSB-VDIM

- |          |                        |           |                              |
|----------|------------------------|-----------|------------------------------|
| <b>1</b> | Keystone Technologies  | <b>7</b>  | Series 1                     |
| <b>2</b> | Canopy Light Fixture   | <b>8</b>  | 80 CRI                       |
| <b>3</b> | LED Technology         | <b>9</b>  | Color Select Technology      |
| <b>4</b> | Max Wattage            | <b>10</b> | Color Select 3000/4000/5000K |
| <b>5</b> | Power Select 40/30/20W | <b>11</b> | 0-10V Dimming                |
| <b>6</b> | Small Size             |           |                              |

### ORDERING EXAMPLES

FIXTURE WITH MULTIPLE FACTORY-INSTALLED ACCESSORIES\*

**KT-CLED40PS-S1-8CSB-VDIM/FC4/L110**

FIXTURE WITH SINGLE FACTORY-INSTALLED ACCESSORY

**KT-CLED40PS-S1-8CSB-VDIM/FC4**

FIXTURE WITH NO FACTORY-INSTALLED ACCESSORIES

**KT-CLED40PS-S1-8CSB-VDIM**

\* When ordering more than one factory-installed accessory, use multiple suffixes as shown in the ordering examples above.  
**Note:** All accessories can also be ordered separately for field installation using just their regular Catalog Number, UPC, or Easy Code.

KEYSTONE FIXTURE	
CATALOG NUMBER	
KT-CLED40PS-S1-8CSB-VDIM	
SENSORS / CONTROLLERS	
SUFFIX	CATALOG NUMBER
✓ /FC4	KTSL-FC4-12V-PKO
LENSES	
SUFFIX	CATALOG NUMBER
✓ /L110	KT-CLED-LENS-S1-110-KIT